

# Trouble Shooting

## SV150T Light Source

**IMPORTANT:** The Restrike period for the lamp when it has been turned OFF and immediately turned back ON is 3-5 minutes. This allows the lamp a period to cool down. It is the normal operation for this lamp.

• **Light Source will not operate:**

- Check if the power switch is in the ON position
- If the unit has a remote control, check the remote control batteries
- Make sure the unit is wired properly

• **Lamp is OFF but the fan is ON:**

- Shut OFF the light source immediately and check the lamp connections.
- If lamp is still not on, replace Lamp

• **Lamp is ON but the fan is OFF:**

- Shut OFF light source immediately and call Service Representative

• **Light Source does not change color:**

- Check that the color switch is in the START position
- Check the color wheel for obstructions
- Check the color wheel nut for tightness
- Check the fibers are not contacting the color wheel

• **Light dims over a period of time:**

- Inspect the fiber head for a clean and smooth cut
- Re-cut the fiber head if it appears otherwise
- Inspect the color wheel and glass filter for clarity - clean if necessary

• **Light Source shuts OFF after running for a while:**

- Check if fan is running
- Check for proper ventilation and ventilation obstructions

• **Fiber is melted at the Fiber Head:**

- Check if fan is running
- Check for proper ventilation
- Check for EndGlow™ black jacket in the Fiber Head - Remove the black jacket and recut the fiber head

# Installation Manual SV150T Light Source

Tower Should Only Be Installed By a Qualified Electrician



SUPER VISION  
INTERNATIONAL

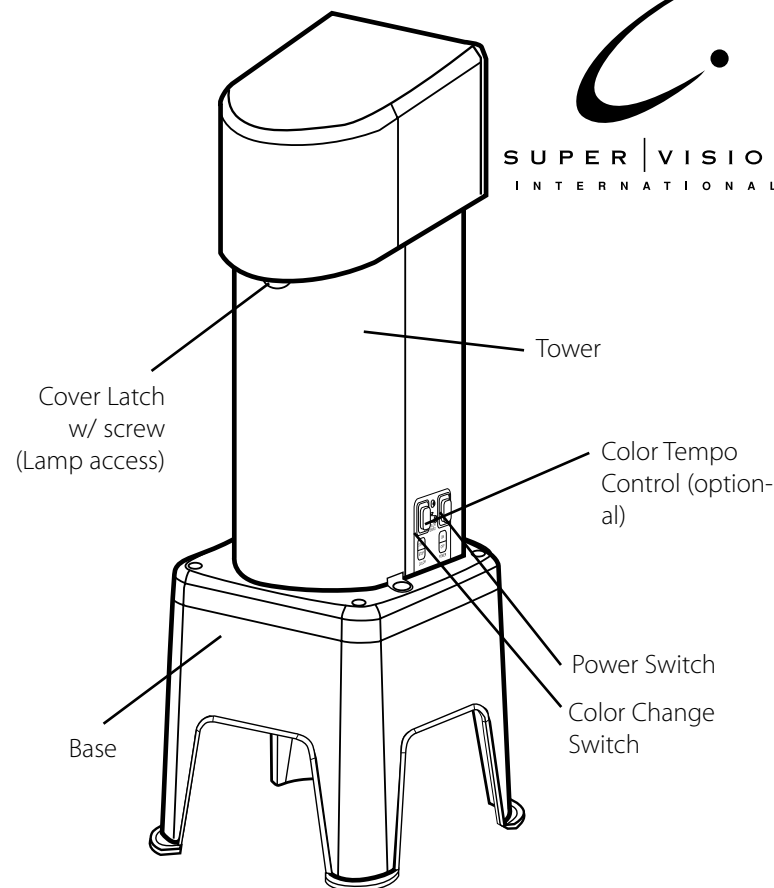

**Specifications:** Tower: 20" High x 6.5" wide x 7" long  
Base: 9.25" High x 9.5" wide x 9.5" long

**Voltage:** 120VAC, 60Hz  
220 VAC , 50Hz

**Fiber Capacity:** 550 strands  
750 strand optional upgrade kit

**Lamp:** 150 watt Metal halide - Proprietary design  
Average Lamp Life: 10,000 hours  
Cool down Restrike period: 3-5 minutes

**Super Vision International, Inc.**

8210 Presidents Drive • Orlando, Florida 32809

Tel: 407.857.9900 • Fax: 407.857.0050

svision.com • email: pools@svision.com



**CAUTION:** Normal setback of the Light Source is 10 feet from the water's edge or 5 feet if a barrier exists. Check your local building codes.

# Installation

## SV150T Light Source

### GENERAL GUIDELINES

#### STEP 1

Position the Base in the ground with approximately 2" remaining above the finished grade. This will provide positive drainage away from the light source. (Fig.1 & 2)

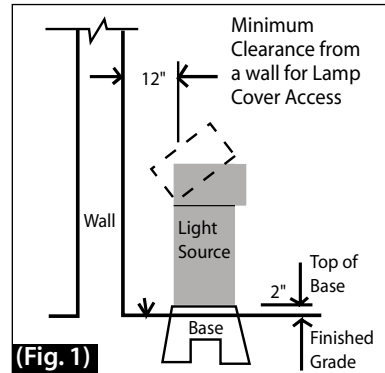

#### STEP 2 - Remove Tower Cover

Remove the Tower cover screws.

Qty. 2, one on each side (Fig. 3)

Remove the Tower Cover. (Fig. 4)

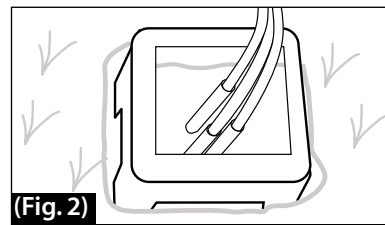

#### STEP 3

Position the Tower over the base and bring the cables and wires through the conduit openings in the bottom of the tower. Then backfill the Base. (Fig 5)

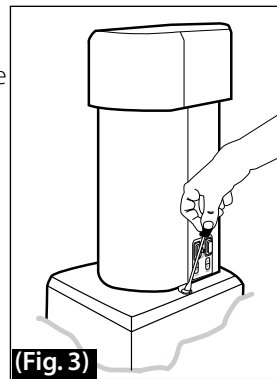

NOTE: Pull all fiber optic cables approximately 12" through the conduit opening, leaving 12" - 18" of extra cable coiled inside the Base.

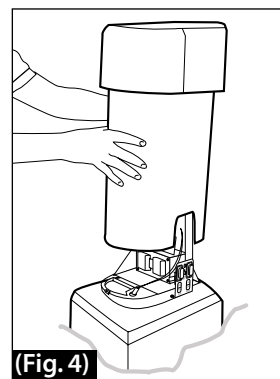

#### STEP 4 - Secure the Tower to the base

Secure the Tower to the base with four screws. (Figs.6)

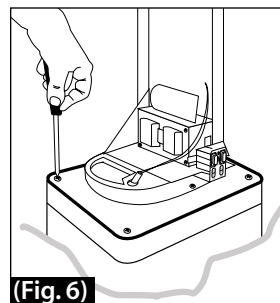
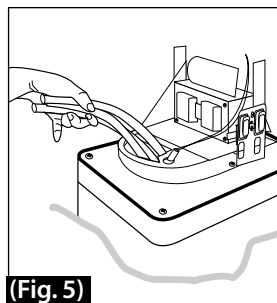

# Lamp Replacement

## SV150T Light Source

Lamp Reorder No. 40-GA

1. **IMPORTANT:** Shut **OFF** the main electrical power to the unit.

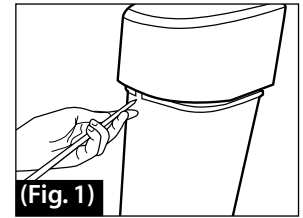

2. Remove access cover screw with a No. 2 Phillips screwdriver (Fig. 1) and open the lid (Fig. 2)

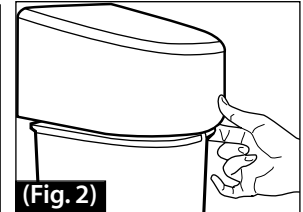
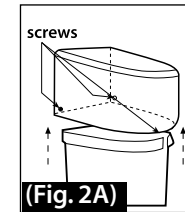

Optional: Remove the 3 cap screws to lift the cap off vertically.

3. Pull off the lamp leads

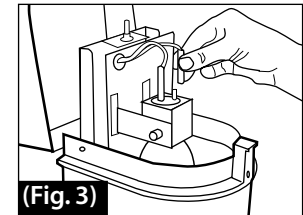

4. Loosen the thumb screw on left side of the lamp bracket while holding the lamp neck. (Fig. 4)

⚠ **CAUTION:**  
The lamp may be HOT.

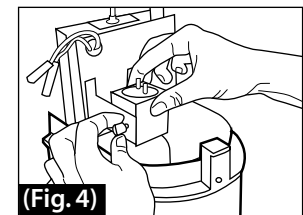

5. Lift out the old lamp. (Fig. 5)

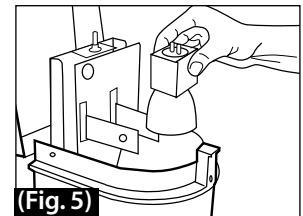

6. Reverse the steps for new lamp replacement. Close the cover and replace the access cover screw before turning the system power back ON.

# Installation

**SV150T Light Source**

## STEP 7 - Replace Tower Cover

After Fiber Head, Electric and Control Systems are complete, replace the Tower Cover and secure it to the base.

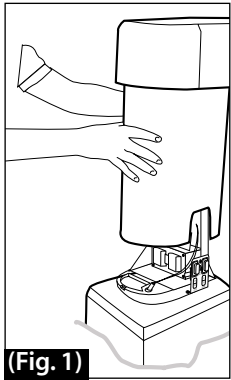

(Fig. 1)

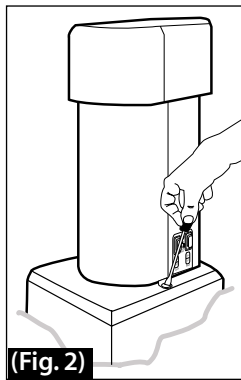

(Fig. 2)

# Operations

**SV150T6C Light Source**

## OPTIONAL - Color Dwell Time Setting    Optional Color Tempo Switch

### Continuous Rotation:

Turn the Color Tempo for quicker changes clockwise, counter-clockwise for slower.

### Time delay on each color:

Turn the Color Tempo switch clockwise. You can adjust the delay from 5 seconds to 1 hour.

**NOTE: Use a number 1 flat head screwdriver to adjust the Color Tempo Switch.**

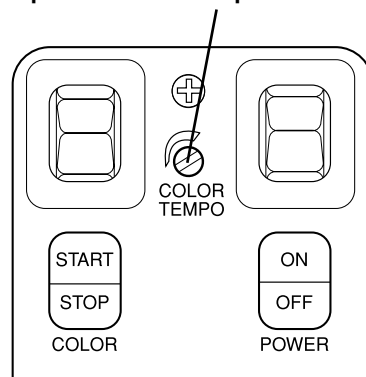

# Installation

**SV150T Light Source**

## STEP 5 PREPARE/INSTALL THE FIBER HEAD

**Fiber Head Capacity:** 550 fibers

**Reducers:** The rings at the tip of each reducer denote the fiber capacity:

- 3 rings = 300 fibers
- 2 rings = 200 fibers
- 1 ring = 100 fibers

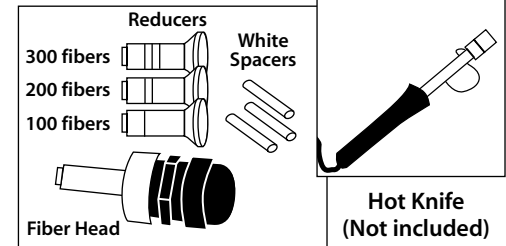

## STEP 5A - Prepare the Fiber

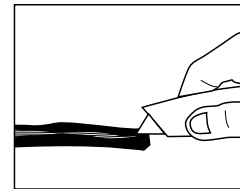

Cut the protective jacket lengthwise being careful not to cut or damage the fibers.

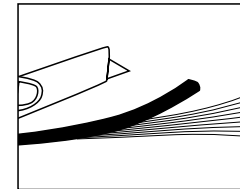

Remove approximately 6" of the protective jacket. Remove center core on SideGlow® cable.

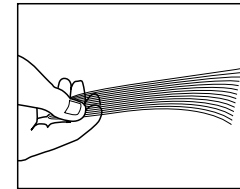

Inspect the fibers making sure none are cut or damaged.

## STEP 5B - Prepare the Fiber Head

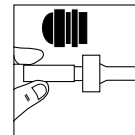

Install a Reducer if necessary.

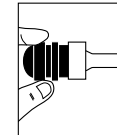

Replace the fiber tight connector.

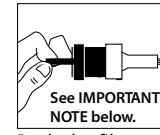

Push the fiber through, making sure it extends past the tip of the Fiber Head.

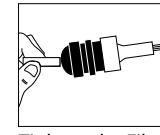

Tighten the Fiber head. Install white spacers if the fiber is loose in the fiber tight connector.

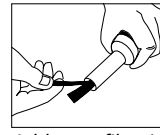

Add extra fiber in the tip until the fiber is tight.

## STEP 5C - Cut the Fiber

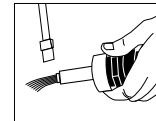

With the Hot knife fully heated...

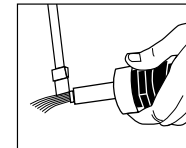

Apply an even pressure on the fibers.

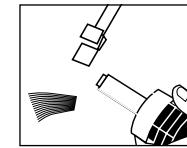

Do not use a sawing motion

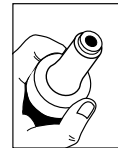

Smooth Cut

## STEP 5D - Install the Fiber Head

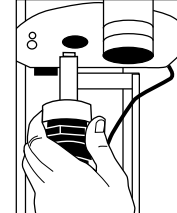

Position the Fiber Head in the slot under the color wheel. Align the tabs on the Fiber Head with the opening.

Turn the Fiber head 90 degrees to the right or left to lock it in place.

**IMPORTANT NOTE:**  
Do not push the black jacket portion of the cable into the Fiber Head. Overheating and melting of the fiber may occur.

# Installation

## SV150T Light Source

### ELECTRICAL STEP 6

#### SINGLE OR STAND-ALONE UNITS

##### Standard Power Hook-up (Fig. 7)

##### Wireless Remote (Single Unit)

1 - Part No. SVRFCK (Transmitter & Receiver)

Install Receiver per detailed instructions included in package. Proceed to the next page and continue wiring per instructions.

##### Hard-Wire to External Remote System - Jandy, Compool, Etc. (Fig. 8a, 8 & 9)

Color Wheel Wiring to External Remote

Toggle switches on all light sources must be in the ON and START position.

#### MULTIPLE UNITS - SYNCHRONOUS UNIT 150T6C ONLY

##### Wireless Remote (Multiple Units) (Fig. 10)

1 - SVRFCK(Transmitter & Receiver)

1 - Receiver only, installed in each additional light source, part no. SVRFR

Install Receivers per detailed instructions included in package. Proceed to the next page and continue wiring per instructions.

##### Hard-Wire to External Remote System - Jandy, Compool, etc. (Fig. 10 & 11)

Run Main Power to each light source per Fig. 9.

Wire Color Wheel relay to Master Light Source only to Stop or Start all Color Wheels in the system. (Fig. 11)

Toggle switches on all light sources must be in the ON and START position.

# Installation

## SV150T Light Source

### ELECTRICAL/CONTROL SYSTEM

(Fig. 7)

#### ELECTRICAL POWER HOOK-UP

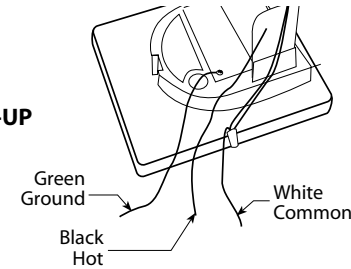

(Fig. 8a)

#### Model sv150T6 Wiring to Jandy

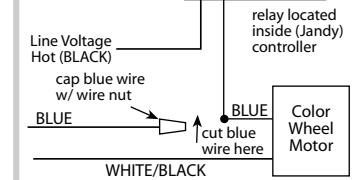

(Fig. 8)

#### Model sv150T6C Wiring to Jandy

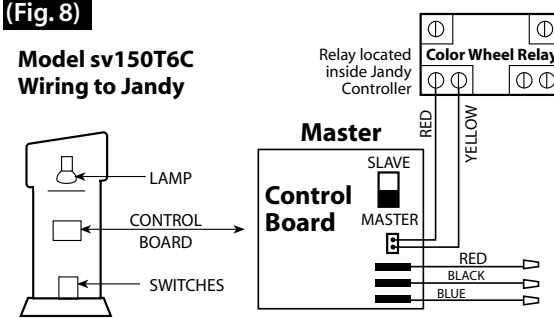

(Fig. 9)

#### MAIN POWER

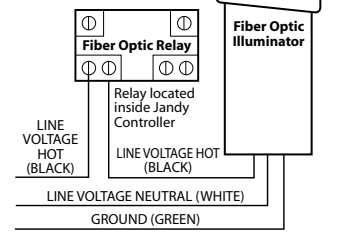

(Fig. 10)

#### Multiple Light Source Control System Wiring - for color synchronization

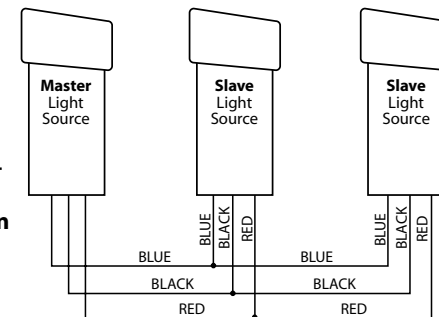

⚠ CAUTION: Run the low voltage data cable in a separate conduit. DO NOT run in the same conduit as high voltage wires.

(Fig. 11)

#### COLOR WHEEL

