



Owner's Manual

AquaLink[®] RS PDA - Pool Digital Assistant



**Pool/Spa Combination Systems and
Pool Only/Spa Only Systems
(Models PS4, PS6, PS8, P4, and P8)**

WARNING

FOR YOUR SAFETY: This product must be installed and serviced by a professional pool/spa service technician. The procedures in this manual must be followed exactly. Failure to follow warning notices and instructions may result in property damage, serious injury, or death.

ATTENTION

This device complies with part 15 of the FCC Rules. Operation is subject to the following two conditions: (1) This device may not cause harmful interference, and (2) this device must accept any interference received, including interference that may cause undesired operation.

NOTE: This equipment has been tested and found to comply with the limits for a Class B digital device, pursuant to part 15 of the FCC Rules. These limits are designed to provide reasonable protection against harmful interference in a residential installation. This equipment generates, uses and can radiate radio frequency energy and, if not installed and used in accordance with the instructions, may cause harmful interference to radio communications. However, there is no guarantee that interference will not occur in a particular installation. If this equipment does cause harmful interference to radio or television reception, which can be determined by turning the equipment off and on, the user is encouraged to try to correct the interference by one or more of the following measures:

- Reorient or relocate the receiving antenna.
- Increase the separation between the equipment and receiver.
- Connect the equipment to an electrical source on a circuit different from that to which the receiver is connected.
- Consult the dealer or an experienced radio/TV technician for help

Modifications made to this equipment, which are not authorized by the manufacturer, may void the user's authority to operate this equipment.

Table of Contents

<p>Section 1. Important Safety Instructions 4</p> <p>Section 2. Overview of the PDA Handheld Remote 6</p> <p>Section 3. Using the Equipment On/Off Menu . 8</p> <p style="padding-left: 20px;">Equipment On/Off..... 8</p> <p style="padding-left: 20px;">Filter Pump 8</p> <p style="padding-left: 20px;">Spa..... 9</p> <p style="padding-left: 20px;">Pool Heat..... 9</p> <p style="padding-left: 20px;">Spa Heat 10</p> <p style="padding-left: 20px;">Solar Heat..... 11</p> <p style="padding-left: 20px;">Auxiliary Equipment 12</p> <p style="padding-left: 20px;">Heat Pump..... 12</p> <p style="padding-left: 20px;">Set Light Colors 13</p> <p>Section 4. Using the Equipment On/Off Model Specific Menus..... 14</p> <p style="padding-left: 20px;">TEMP1 (Pool or Spa Only) 14</p> <p style="padding-left: 20px;">TEMP2 (Pool or Spa Only) 14</p> <p style="padding-left: 20px;">Two Speed Operation..... 15</p> <p>Section 5. Using the Menus..... 16</p> <p style="padding-left: 20px;">Service Menu 16</p> <p style="padding-left: 20px;">Diagnostics Menu 16</p> <p style="padding-left: 20px;">Program Menu 17</p> <p style="padding-left: 20px;">Set Temperature Menu 18</p> <p style="padding-left: 20px;">Set Time Menu..... 18</p> <p style="padding-left: 20px;">AquaPure Menu 19</p> <p style="padding-left: 20px;">Auto Shut-off Menu 19</p> <p style="padding-left: 20px;">Backlight Menu..... 20</p> <p style="padding-left: 20px;">Assign Hotkeys Menu..... 20</p> <p style="padding-left: 20px;">System Setup Menu 21</p> <p style="padding-left: 20px;">Boost Menu 21</p>	<p>Section 6. Using the System Setup Menu 22</p> <p style="padding-left: 20px;">Label Auxiliary Menu 22</p> <p style="padding-left: 20px;">Boost Setup Menu 23</p> <p style="padding-left: 20px;">Freeze Protection Menu 23</p> <p style="padding-left: 20px;">Air Temperature Menu..... 24</p> <p style="padding-left: 20px;">Degrees C/F Menu 25</p> <p style="padding-left: 20px;">Temp Calibration Menu 25</p> <p style="padding-left: 20px;">Solar Priority 26</p> <p style="padding-left: 20px;">Pump Lockout Menu..... 26</p> <p style="padding-left: 20px;">Assign JVA Menu 27</p> <p style="padding-left: 20px;">Set Color Lights Menu..... 27</p> <p style="padding-left: 20px;">Spa Side Switch Menu 28</p> <p style="padding-left: 20px;">Service Info Menu..... 28</p> <p style="padding-left: 20px;">Clear Memory Menu..... 29</p> <p style="padding-left: 20px;">Heat Pump Menu 30</p> <p>Section 7. Glossaries 31</p> <p>Section 8. PDA Handheld Remote Menu Flow Chart..... 33</p> <p>Section 9. General, Water Feature, and Light Aux Labels 34</p>
---	---

EQUIPMENT INFORMATION RECORD	
DATE OF INSTALLATION _____	
INSTALLER INFORMATION _____	
INITIAL PRESSURE GAUGE READING (WITH CLEAN FILTER) _____	
PUMP MODEL _____	HORSEPOWER _____
FILTER MODEL _____	SERIAL NUMBER _____
PDA HANDHELD REMOTE MODEL _____	SERIAL NUMBER _____
NOTES: _____	

Section 1. Important Safety Instructions

READ AND FOLLOW ALL INSTRUCTIONS

LIRE LA NOTICE TECHNIQUE.

All electrical work must be performed by a licensed electrician and conform to all national, state, and local codes. When installing and using this electrical equipment, basic safety precautions should always be followed, including the following:

DANGER

To reduce the risk of injury, do not remove the suction fittings of your spa or hot tub. Never operate a spa or hot tub if the suction fittings are broken or missing. Never replace a suction fitting with one rated less than the flow rate marked on the equipment assembly.

WARNING

Prolonged immersion in hot water may induce hyperthermia. Hyperthermia occurs when the internal temperature of the body reaches a level several degrees above the normal body temperature of 98.6° F. The symptoms of hyperthermia include dizziness, fainting, drowsiness, lethargy, and an increase in the internal temperature of the body. The effects of hyperthermia include: 1) unawareness of impending danger; 2) failure to perceive heat; 3) failure to recognize the need to exit spa; 4) physical inability to exit spa; 5) fetal damage in pregnant women; 6) unconsciousness resulting in a danger of drowning.

WARNING

To Reduce the Risk of Injury -

- a) The water in a spa should never exceed 104°F (40°C). Water temperatures between 100°F (38°C) and 104°F (40°C) are considered safe for a healthy adult. Lower water temperatures are recommended for young children and when spa use exceeds 10 minutes.
- b) Since excessive water temperatures have a high potential for causing fetal damage during the early months of pregnancy, pregnant or possibly pregnant women should limit spa water temperatures to 100°F (38°C).
- c) Before entering a spa or hot tub, the user should measure the water temperature with an accurate thermometer since the tolerance of water temperature-regulating devices varies.
- d) The use of alcohol, drugs, or medication before or during spa or hot tub use may lead to unconsciousness with the possibility of drowning.
- e) Obese persons and persons with a history of heart disease, low or high blood pressure, circulatory system problems, or diabetes should consult a physician before using a spa.
- f) Persons using medication should consult a physician before using a spa or hot tub since some medication may induce drowsiness while other medication may affect heart rate, blood pressure, and circulation.

WARNING

Risk of electric shock - Install the power center at least five (5) feet (152.4cm) from the inside wall of the pool and/or hot tub using non-metallic plumbing. Canadian installations must be at least three (3) meters from the water.

Children should not use spas or hot tubs without adult supervision.

Do not use spas or hot tubs unless all suction guards are installed to prevent body and hair entrapment.

People using medications and/or having an adverse medical history should consult a physician before using a spa or hot tub.

AVERTISSEMENT

Danger d'electrocution - Les installations Canadiennes doivent se trouver à au moins trois (3) mètres de l'eau.

Ne pas laisser les enfants utiliser une cuve de relaxation sans surveillance.

Pour éviter que les cheveux ou une partie du corps puissent être aspirés, ne pas utiliser une cuve de relaxation si les grilles de prise d'aspiration ne sont pas toutes en place.

Les personnes qui prennent des médicaments ou ont des problèmes de santé devraient consulter un médecin avant d'utiliser une cuve de relaxation.

⚠ WARNING

People with infectious diseases should not use a spa or hot tub.
 To avoid injury, exercise care when entering or exiting the spa or hot tub.
 Do not use drugs or alcohol before or during the use of a spa or hot tub to avoid unconsciousness and possible drowning.
 Pregnant or possibly pregnant women should consult a physician before using a spa or hot tub.
 Water temperature in excess of 100°F/38°C may be injurious to your health.
 Before entering a spa or hot tub measure the water temperature with an accurate thermometer.
 Do not use a spa or hot tub immediately following strenuous exercise.
 Prolonged immersion in a spa or hot tub may be injurious to your health.
 Do not permit any electric appliance (such as a light, telephone, radio, or television) within 5 feet (1.5 m) of a spa or hot tub.
 The use of alcohol, drugs or medication can greatly increase the risk of fatal hyperthermia in hot tubs and spas.
 Water temperature in excess of 100°F/38°C may be hazardous to your health.

⚠ AVERTISSEMENT

Les personnes atteintes de maladies infectieuses ne devraient pas utiliser une cuve de relaxation.
 Pour éviter des blessures, user de prudence en entrant dans une cuve de relaxation et en sortant.
 Pour éviter l'évanouissement et la noyade éventuelle, ne prendre ni drogue ni alcool avant d'utiliser une cuve de relaxation ni quand on s'y trouve.
 Les femmes enceintes, que leur grossesse soit confirmée ou non, devraient consulter un médecin avant d'utiliser une cuve de relaxation.
 Il peut être dangereux pour la santé de se plonger dans de l'eau à plus de 38°C/100°F.
 Avant d'utiliser une cuve de relaxation mesurer la température de l'eau à l'aide d'un thermomètre précis.
 Ne pas utiliser une cuve de relaxation immédiatement après un exercice fatigant.
 L'utilisation prolongée d'une cuve de relaxation peut être dangereuse pur la santé.
 Ne pas placer d'appareil électrique (luminaire, téléphone, radio, téléviseur, etc) à moins de 1.5m de cette cuve de relaxation.
 La consommation d'alcool ou de drogue augmente considérablement les risques d'hyperthermie mortelle dans une cuve de relaxation.
 Il peut être dangereux pour la santé de se plonger dans de l'eau à plus de 38°C/100°F.

⚠ WARNING

To avoid injury ensure that you use this control system to control only packaged pool/spa heaters which have built-in operating and high limit controls to limit water temperature for pool/spa applications. This device should not be relied upon as a safety limit control.

⚠ CAUTION

A terminal bar marked "GROUND" is provided within the power center. To reduce the risk of electrical shock, connect this terminal bar to the grounding terminal of your electric service or supply panel with a continuous copper conductor having green insulation and one that is equivalent in size to the circuit conductors supplying this equipment, but no smaller than no. 12 AWG (3.3mm). In addition, a second wire connector should be bonded with a no. 8 AWG (4.115mm) copper wire to any metal ladders, water pipes, or other metal within five (5) feet (1.52m) of the tub.

⚠ CAUTION

A ground-fault circuit-interrupter must be provided if this device is used to control underwater lighting fixtures. The conductors on the load side of the ground-fault circuit-interrupter shall not occupy conduit, boxes, or enclosures containing other conductors unless the additional conductors are also protected by a ground-fault circuit-interrupter. Refer to local codes for complete details.



Attention installer: Install to provide drainage of compartment for electrical components.

SAVE THESE INSTRUCTIONS

Section 2. Overview of the PDA Handheld Remote

This document gives instructions for operating the Jandy AquaLink® RS PDA Handheld Remote. The instructions must be followed exactly. Read through the instructions completely before operating the equipment.

2.1 Basic Functions

The AquaLink RS PDA Handheld Remote can turn your pool/spa equipment on and off in any of the following three ways:

1. Activate the equipment manually through the EQUIPMENT ON/OFF menu.
2. Program the equipment to turn on and off at specific times. See page 17 for a detailed explanation of how to program equipment for automatic operation.
3. Use the PDA Handheld Remote buttons 1 or 2 (Hotkeys). See page 20 for a detailed explanation of how to program Hotkeys 1 and 2.

NOTE The default setting for Hotkeys 1 and 2 are AUX1 and AUX2 respectively. However, these buttons can be assigned to any piece of equipment connected to a circuit or relay.

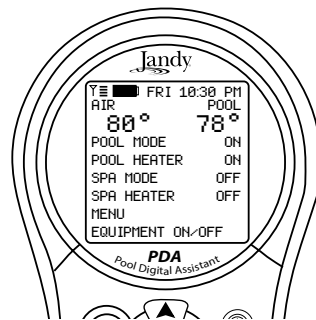

Default screen

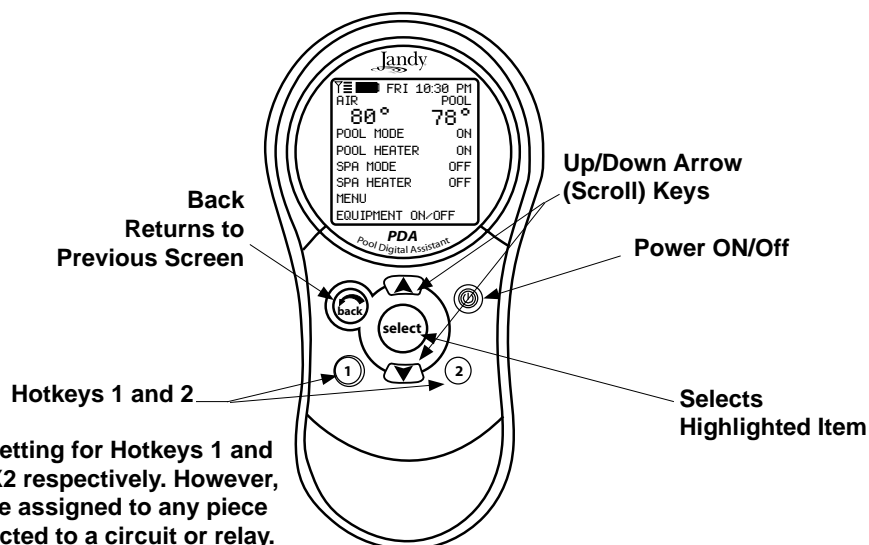

2.2 Using the Buttons

Use the buttons as explained in the diagram below.



NOTE The default setting for Hotkeys 1 and 2 are AUX1 and AUX2 respectively. However, these buttons can be assigned to any piece of equipment connected to a circuit or relay.

2.3 Battery Status

The Battery icon  , located on the left corner of the display screen, indicates the status of the battery. The PDA Handheld Remote uses two (2) AA batteries. The batteries are located behind the cover on the back side of the Handheld Remote. If the batteries have full or sufficient charge, the icon will appear on the display screen as  . If the batteries need to be replaced, the icon will consistently blink and appear as  .

2.4 Signal Strength

The Signal Strength icon  , located on the left corner of the display screen, indicates the signal strength available from the Transceiver J-box to the PDA Handheld Remote. Signal strength is affected (lowered) as the PDA Handheld Remote is moved farther away from the Transceiver J-Box. Also, obstructions, such as walls, can lower the signal strength if located between the PDA Handheld Remote and the Transceiver J-Box.

Section 3. Using the Equipment On/Off Menu

Equipment On/Off

Use this menu to manually turn a piece of equipment on or off. The ALL OFF mode will turn off equipment that has been turned on by any means (manual or pre-programmed). This includes any of the heater enables that were on (unless in use by the Maintain function).

To use Equipment On/Off

1. Highlight EQUIPMENT ON/OFF and press SELECT. To highlight an item, use the UP/DOWN arrow keys. Use the SELECT button to turn the equipment on or off. Return to the main menu by using the BACK button, or use the UP/DOWN arrow keys to highlight another device.
2. Highlight ALL OFF and press SELECT. After using ALL OFF, return to the main menu by using the BACK button.

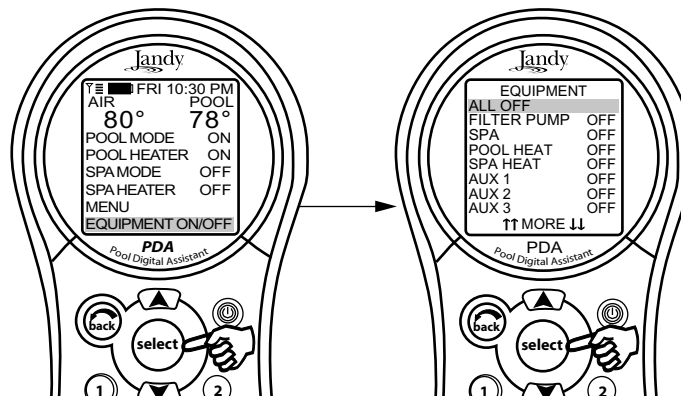

Filter Pump

The FILTER PUMP selection turns the main filtration pump on or off for circulation to the pool. The filter pump also activates if the spa is turned on, if the pool cleaner is turned on, or if the spa spill-over effect is activated. The main filtration pump circulates the pool or spa water through the filter and heater. The pump must be on if you want to display the pool temperature, or if you want to heat the pool.

For 2-speed operation, see page 15.

To use Filter Pump

Highlight FILTER PUMP and press SELECT. Use the SELECT button to turn the equipment on or off.

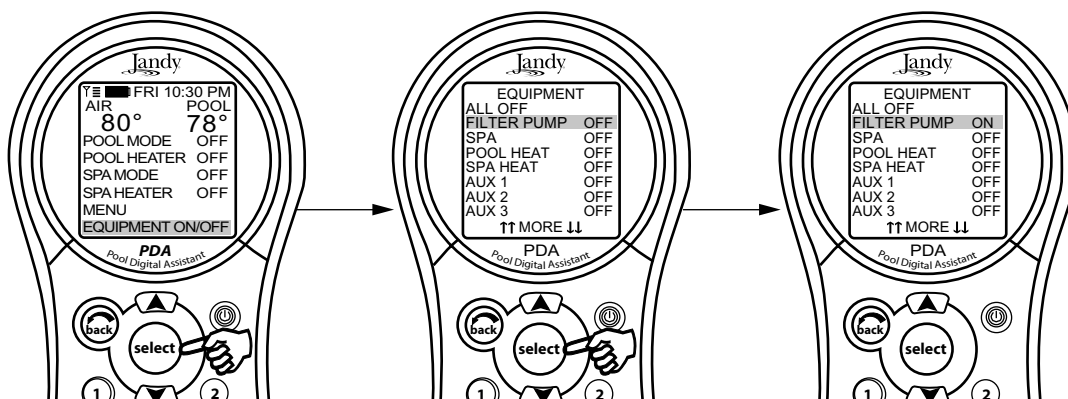

Spa

The SPA mode switches water circulation from the pool to spa (pool/spa combination models only). Turning on the spa also activates the filter pump (after a delay for valve rotation) and deactivates the pool cleaner if it is on. The SPA mode must be on to display the spa temperature and/or to heat the spa. Activation takes place after a thirty second delay (while valves are turning).

To use Spa

Highlight SPA and press SELECT. Use the SELECT button to turn the spa on or off.

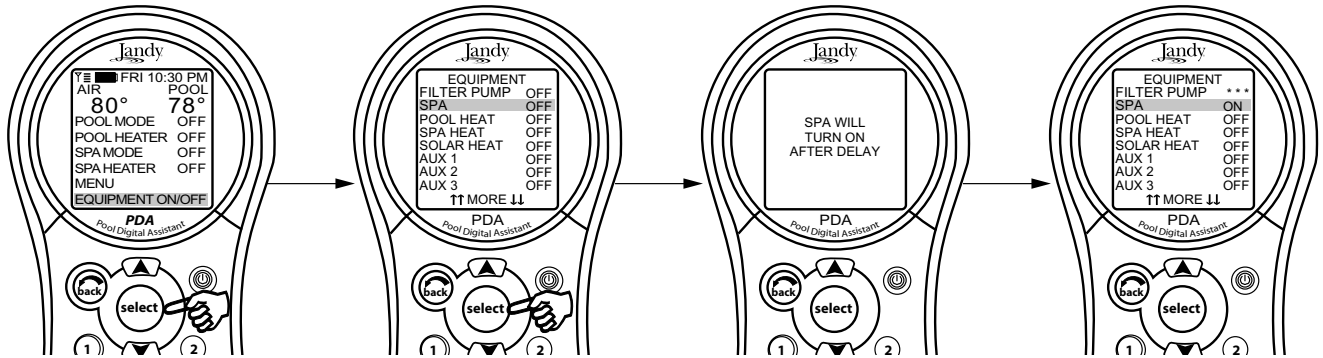

Pool Heat

The POOL HEAT selection enables the heater for the pool. It uses the setting from SET TEMP menu, or you can increase/decrease when enabling.

To use Pool Heat

Highlight FILTER PUMP and press SELECT. Highlight POOL HEAT and press SELECT. Use the UP/DOWN arrow keys to set the desired temperature and press SELECT.

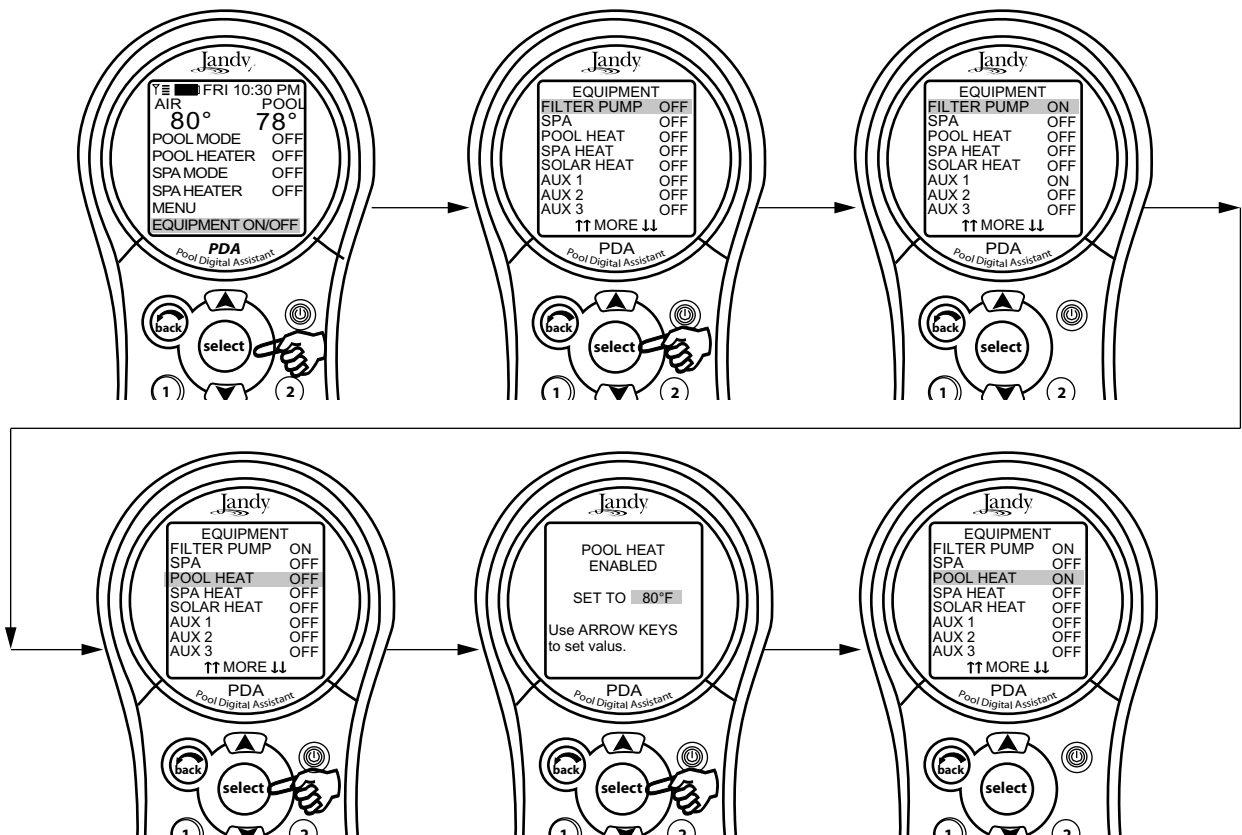

Spa Heat

The SPA HEAT enables the heater for the spa. The desired temperature can be set from the SET TEMP menu, or you can increase/decrease the temperature when enabling the heater.

To use Spa Heat

Highlight SPA and press SELECT. The spa will come on after a short delay. Highlight SPA HEAT and press SELECT. Use the UP/DOWN arrow keys to set the desired temperature and press SELECT.

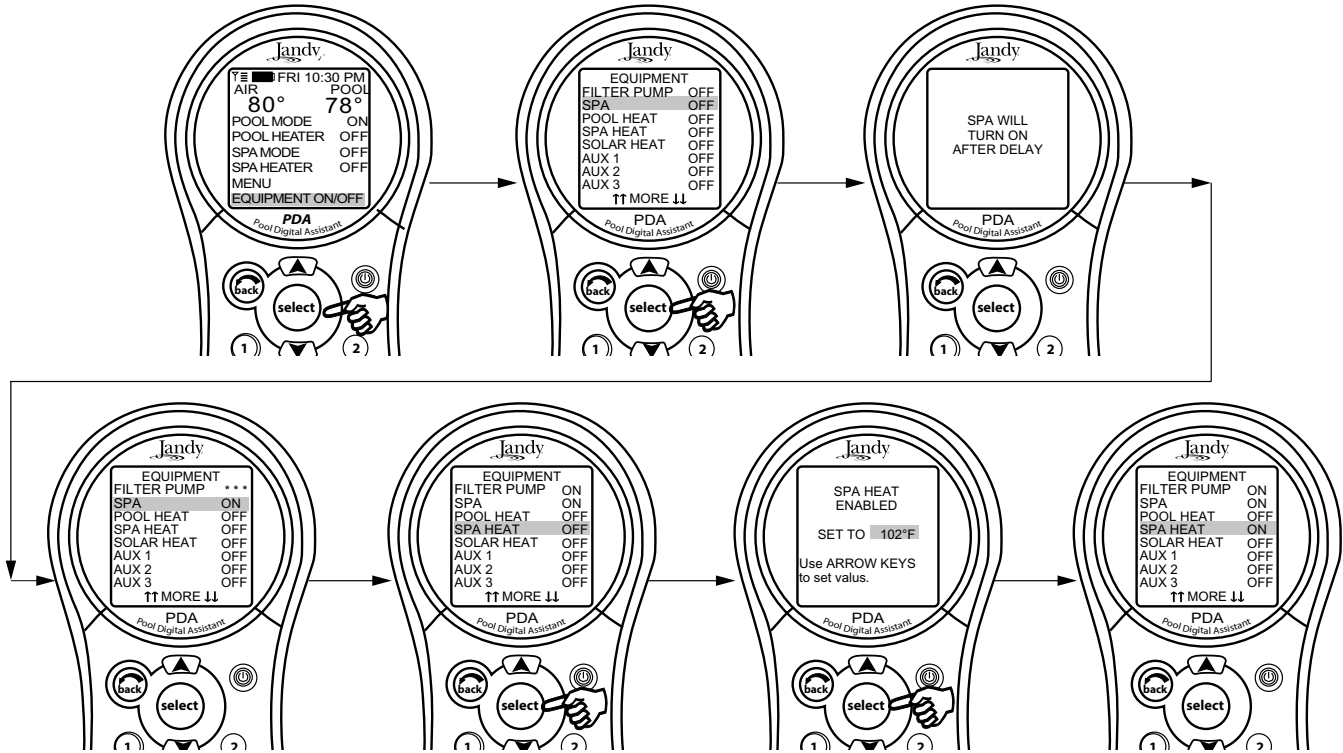

Solar Heat

The SOLAR HEAT selection controls solar heating. A solar heating system and optional solar sensor are required for SOLAR HEAT selection to operate and must be part of the normal circulation system.

To use Solar Heat

Highlight SOLAR HEAT and press SELECT. Use the SELECT button to turn SOLAR HEAT on or off.

HEAT PUMP: If the solar circuit is controlling a heat pump, the label HEAT PUMP will appear on the screen in place of SOLAR HEAT.

NOTE The label HEAT PUMP may take up to 24 hours to appear on the screen after initial heat pump installation.

If a solar sensor is not installed, EXTRA AUX replaces SOLAR HEAT and may be used to control an auxiliary (see "Auxiliary Equipment" to turn on or off EXTRA AUX).

For solar heating to take place, the SOLAR HEAT (in EQUIPMENT ON/OFF) must be enabled, also the filter pump must be on. Solar temperature must be at least 5° F above the water temperature and the water must be cooler than the thermostat setting.

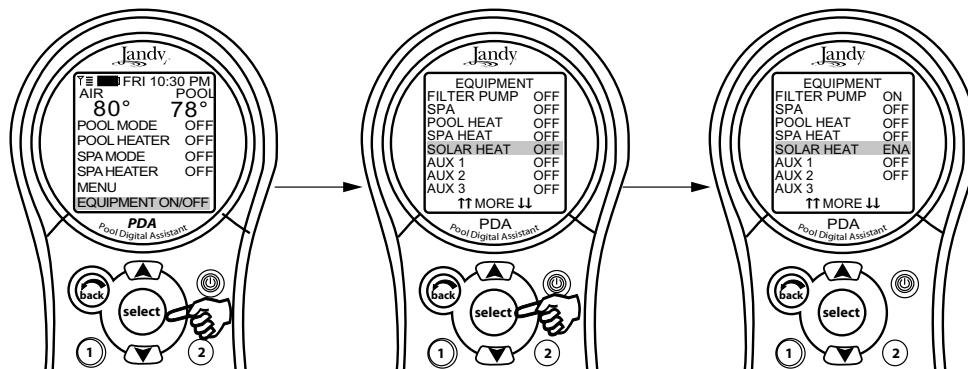

NOTE If no Solar Sensor is installed, EXTRA AUX will appear as a menu item.

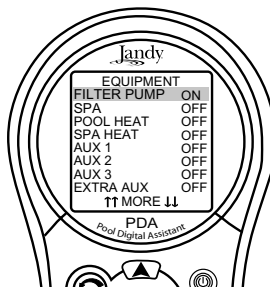

Auxiliary Equipment

The AUX modes control each of the auxiliary devices plus an extra AUX. To assign a different name to an auxiliary device, use the SYSTEM SETUP and LABEL AUX menus.

NOTE Auxiliary devices are items or equipment such as pool and spa lights, waterfalls, or air blowers.

To turn an Auxiliary on or off

Highlight EQUIPMENT ON/OFF and press SELECT. Highlight an AUX and press SELECT. Use the SELECT button to turn the equipment on or off.

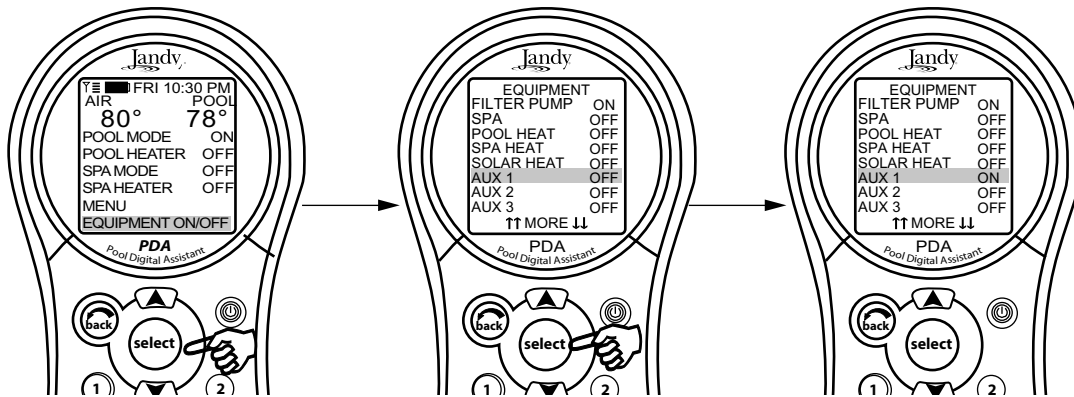

Heat Pump

NOTE This equipment may not be part of your system. Please check with your installer.

The HEAT PUMP selection controls the heat pump operation. In order to use the heat pump, the filter pump must be turned on and the heat pump must be in HEAT MODE (see *Section 5, System Setup Menu*, on page 21), and the switch on the heat pump on the equipment pad must also be set to HEAT MODE.

NOTE HEAT PUMP takes the place of EXTRA AUX or SOLAR HEAT. It is not possible to have any two of these on the EQUIPMENT ON/OFF menu at the same time.

To use Heat Pump

Highlight EQUIPMENT ON/OFF and press SELECT. Highlight HEAT PUMP and press SELECT. Press the SELECT button to enable/disable the HEAT PUMP. The HEAT PUMP uses the SET TEMP set point.

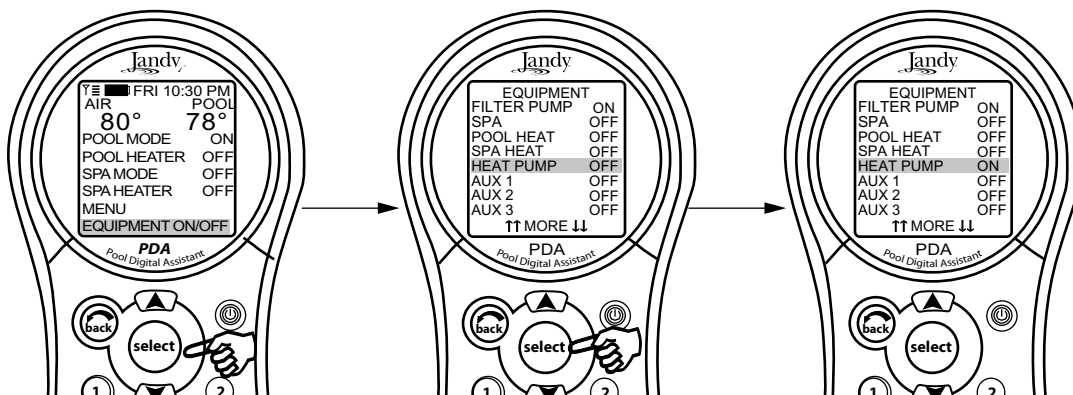

Set Light Colors

NOTE This equipment may not be part of your system. Please check with your installer.

The SET COLOR menu is used to set the color of a color light and then turn the light on.

NOTE Prior to setting the color of the light, the light must be assigned and controlled by an auxiliary (for example, AUX 1). See "Using System Setup" to assign the light to an auxiliary control. Please note that the auxiliary control can be custom labeled.

To use Set Colors

Highlight EQUIPMENT ON/OFF and press SELECT. Highlight the auxiliary assigned to the color light and press SELECT. A list of available colors will be displayed. The most recently selected color will be highlighted. Use the UP/DOWN arrow keys to highlight the desired color and press SELECT.

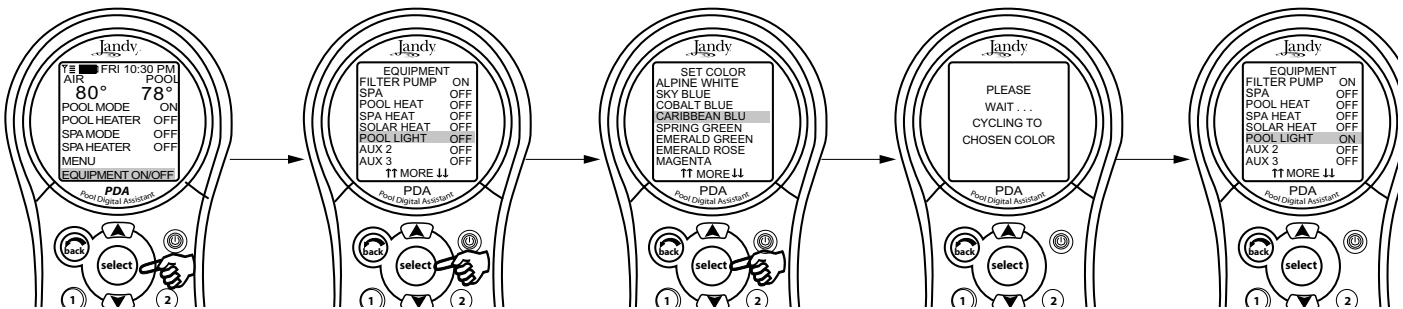

NOTE If you select POOL LIGHT or SPA LIGHT from the EQUIPMENT ON/OFF menu and the light is already ON, pressing SELECT will display the message "LIGHT WILL TURN OFF IN 5 SECONDS. IF YOU WANT TO CHANGE THE COLOR PRESS SELECT NOW". If you press SELECT, the SET COLOR menu will open and allow you to select a different color. If a different color is chosen, the light will reset to Alpine White, rotate to the selected color, and then automatically lock on to that color. During the color rotation, the message "PLEASE WAIT...CYCLING TO CHOSEN COLOR" will be displayed.

When a pool or spa light is turned ON manually, by the PDA Handheld Remote panel, or by a program, the last used color will automatically be chosen unless you press SELECT to change the color.

If you press the BACK key when in the EQUIPMENT ON/OFF menu, the light will turn on the last selected color. If the SELECT key or the BACK key is not pressed, and if it has been 15 seconds since the UP/DOWN keys have been pressed, then the most recently selected color will be selected again.

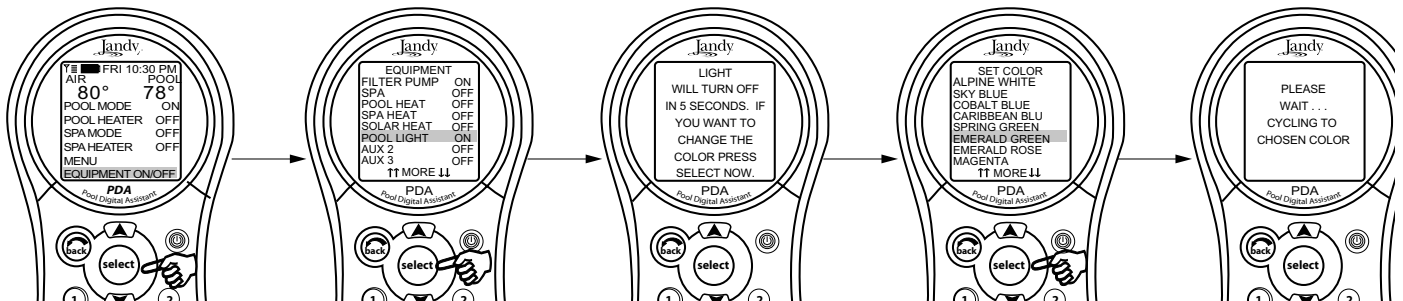

Important Information

Do not activate this feature unless you are certain that color lights are installed on your system

Section 4. Using the Equipment On/Off Model Specific Menus

TEMP1 (Pool or Spa Only)

NOTE This equipment may not be part of your system. Please check with your installer.

TEMP1 is the priority temperature. It must be set higher than **TEMP2**, and it overrides **TEMP2** whenever it is enabled. Set temperature for **TEMP1** before setting temperature for **TEMP2**.

To set TEMP1 (Pool or Spa Only)

Highlight EQUIPMENT ON/OFF and press SELECT. Highlight TEMP1 and press SELECT twice. Use the UP/DOWN arrow keys to set the desired water temperature and press SELECT to make that degree setting take effect. Return to the main menu by using the BACK button.

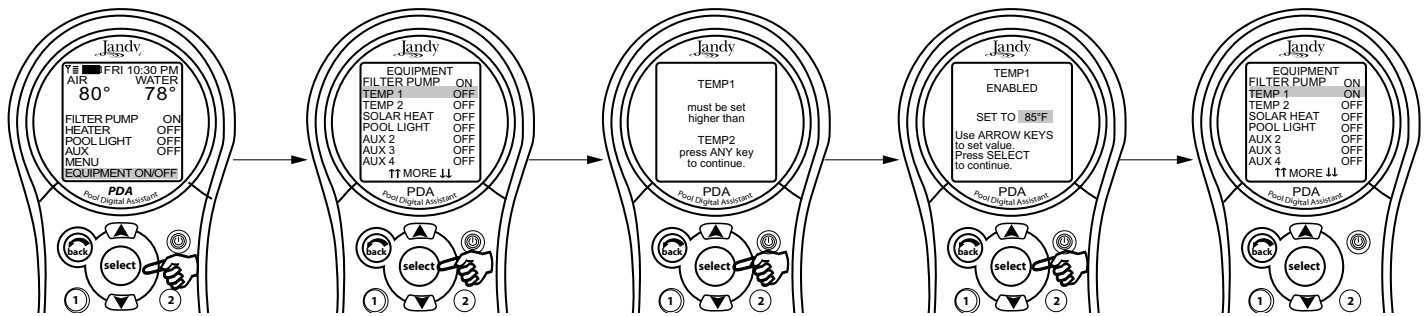

TEMP2 (Pool or Spa Only)

NOTE This equipment may not be part of your system. Please check with your installer.

TEMP2 is the maintenance (low) temperature. It must be set lower than **TEMP1**. If **TEMP2** is on and **TEMP1** is activated, **TEMP2** will turn off and ENABLED will flash. When **TEMP1** is turned off again, **TEMP2** will reactivate.

To set TEMP2 (Pool or Spa Only)

Highlight EQUIPMENT ON/OFF and press SELECT. Highlight TEMP2 and press SELECT twice. Use the UP/DOWN arrow keys to set the desired water temperature and press SELECT to make that degree setting take effect. Return to the main menu by using the BACK button.

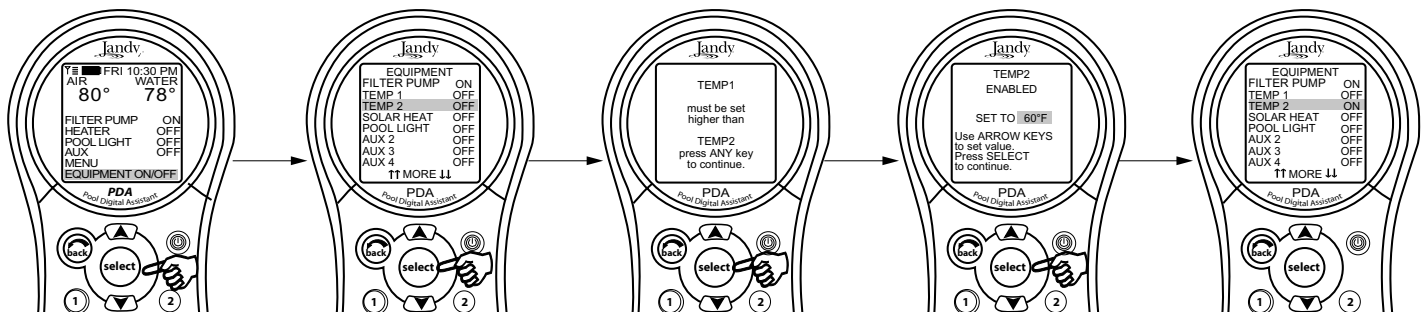

Two Speed Operation

NOTE This equipment may not be part of your system. Please check with your installer.
Optional TWO SPEED RELAY required.

Two Speed Manual Operation

- **For Pool and Spa Combination Units**

If your control is a POOL and SPA combination with a 2-speed filtration pump, the control will operate as follows: HIGH SPEED (Filter Pump) must be on before LOW SPEED. Filter Pump button, as well as the Spa button, turns it to HIGH SPEED. LOW SPEED (AUX 2) button toggles back and forth from LOW to HIGH.

- **For Pool or Spa Only Units**

To use HIGH/LOW Speeds, Filter Pump turns on HIGH SPEED, AUX 2 turns on LOW SPEED. Whatever mode last used is the off button. To toggle, press whichever speed is not on.

- **Two Speed Programming for All Units**

When programming HIGH and LOW Speeds to operate together, think of HIGH SPEED (Filter Pump) as total duration of filtration time, then set Low Speed (AUX 2) to operate within that duration. For example, if you want High Speed on for 2 hours and Low Speed for 10 hours, program the Filter Pump (High Speed) from 8 AM to 8 PM and Low Speed from 10 AM to 8 PM.

NOTE It is not necessary to program both HIGH and LOW Speeds, even with a Combo Control System. If only LOW SPEED is programmed, HIGH SPEED will turn on at the LOW SPEED on time to prime the pump. After 3 minutes the system will switch to LOW SPEED for the remainder of its programmed time.

Section 5. Using the Menus

Service Menu

In the HELP menu, you will find the SERVICE menu. The SERVICE menu gives you the phone number (if entered) for your local service company. See SERVICE INFO menu, under SYSTEM SETUP, to enter your local service company information.

To use the Service menu

Highlight MENU and press SELECT, highlight HELP and press SELECT. Highlight SERVICE by using the UP/DOWN arrow keys and press SELECT.

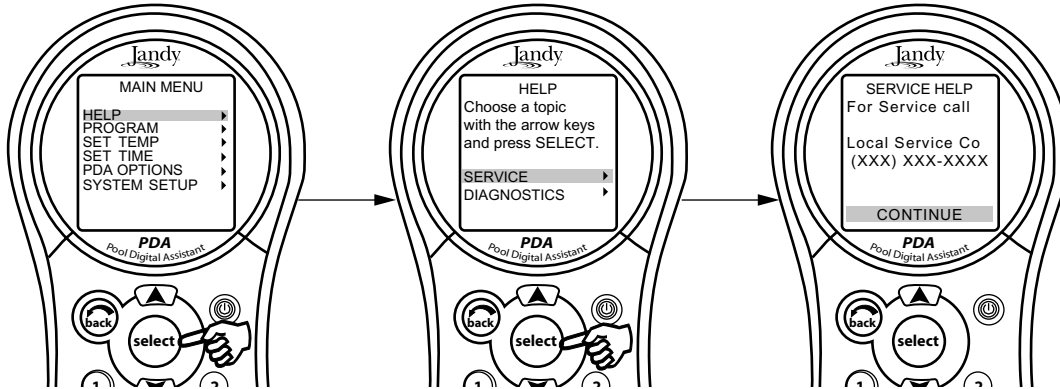

Diagnostics Menu

In the HELP menu, you will find the DIAGNOSTICS menu. The DIAGNOSTICS menu tells you the model, type, firmware revision level, battery status, and time calibration. Also, the connection of temperature sensors is checked.

To use the Diagnostics menu

Highlight MENU and press SELECT, highlight HELP and press SELECT. Highlight DIAGNOSTICS by using the UP/DOWN arrow keys and press SELECT. Select CONTINUE. The status of the temperature sensors is displayed. Select CONTINUE and a check of the remote(s) will be run. Select CONTINUE and the system will check for errors.

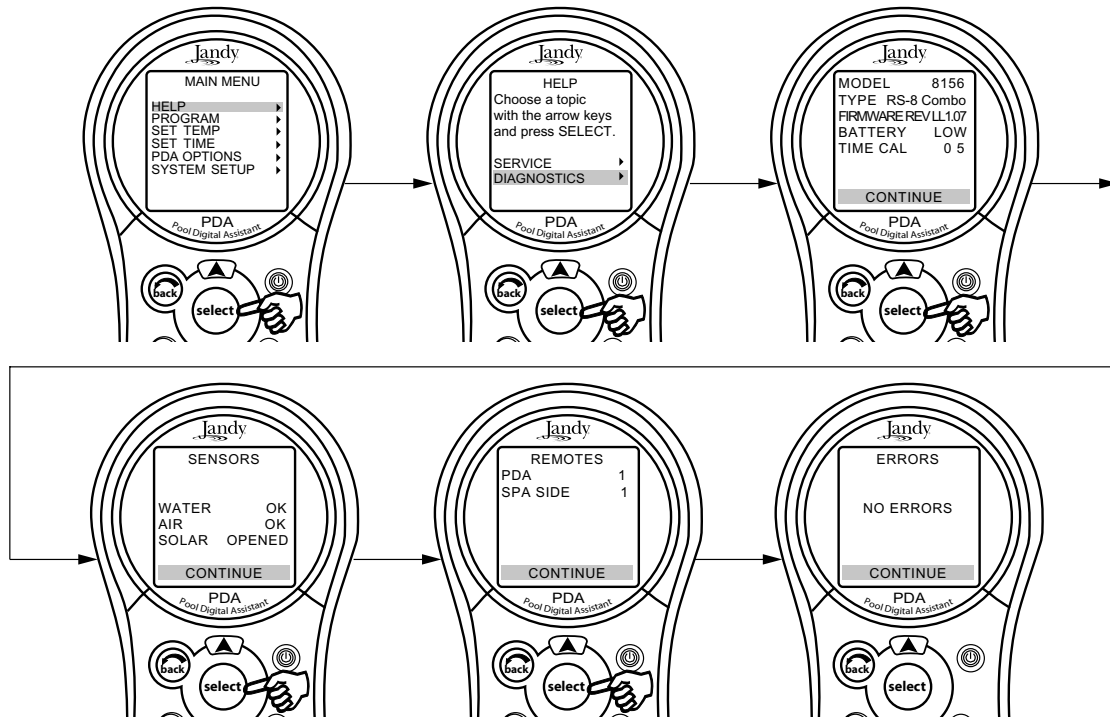

Program Menu

The Program menu allows automatic on and off times for any equipment controlled by the AquaLink RS. You can program equipment to turn on or off all days, weekends, or weekdays. Each piece of equipment can be programmed for multiple on/off times each day.

To set automatic on and off times

Highlight MENU and press SELECT, highlight PROGRAM and press SELECT. While in the PROGRAM menu, highlight the piece of equipment and press SELECT, highlight ADD PROGRAM and press SELECT. Enter the ON/OFF times and the range of days (for example, Weekdays, Weekends, All Days) by using the UP/DOWN arrow buttons to set values and the SELECT button to continue. When the range of days has been selected, the screen will change to show the piece of equipment selected, number of programs, on/off times, day range selected, and the chance to delete or change any of the settings to a program. Use the BACK button to go to the previous screen.

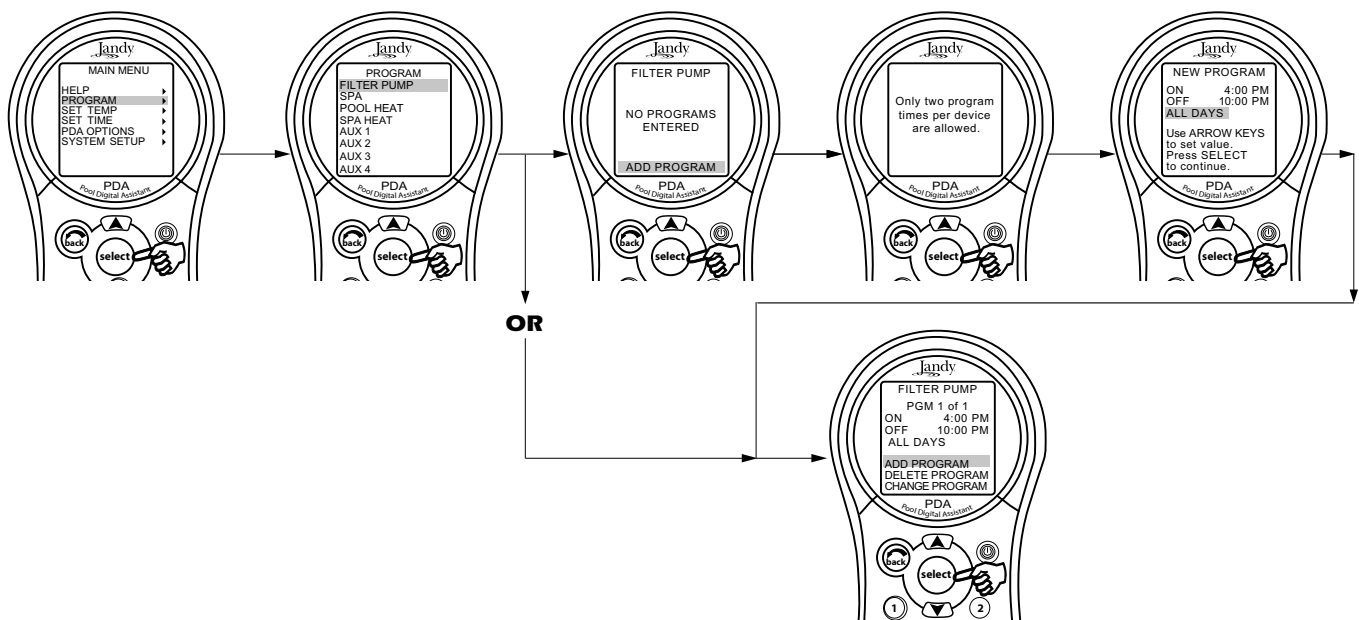

To add programs use the PROGRAM menu. Select the equipment/AUX you want to add a program to and press Select. Highlight ADD PROGRAM, and press SELECT. Use UP/DOWN arrows to set times, press SELECT to continue.

To delete programs, use the PROGRAM menu. Highlight DELETE PROGRAM, and press SELECT. Program to be deleted must be displayed on screen. To scroll through multiple programs, highlight NEXT and press SELECT.

To change programs, also use the PROGRAM menu. Highlight CHANGE PROGRAM, and press SELECT. Program to be changed must be displayed on screen. To scroll through multiple programs, use the UP/DOWN arrows keys to select the program to be changed.

Set Temperature Menu

The SET TEMP menu allows you to preset the pool and spa thermostats.

NOTE For pool/spa combination systems, the default pool temperature is 80°F and the default spa temperature is 102°F. For pool only/spa only systems, the default TEMP1 temperature is 80°F and the default TEMP2 temperature is 60°F.

To set Pool/Spa Temperatures

Highlight MENU and press SELECT, highlight SET TEMP and press SELECT. Inside the SET TEMP menu, use the UP/DOWN arrow keys to highlight either POOL (TEMP1) or SPA (TEMP2) and press SELECT. Use the UP/DOWN arrow keys to increase or decrease the temperature and press SELECT to apply.

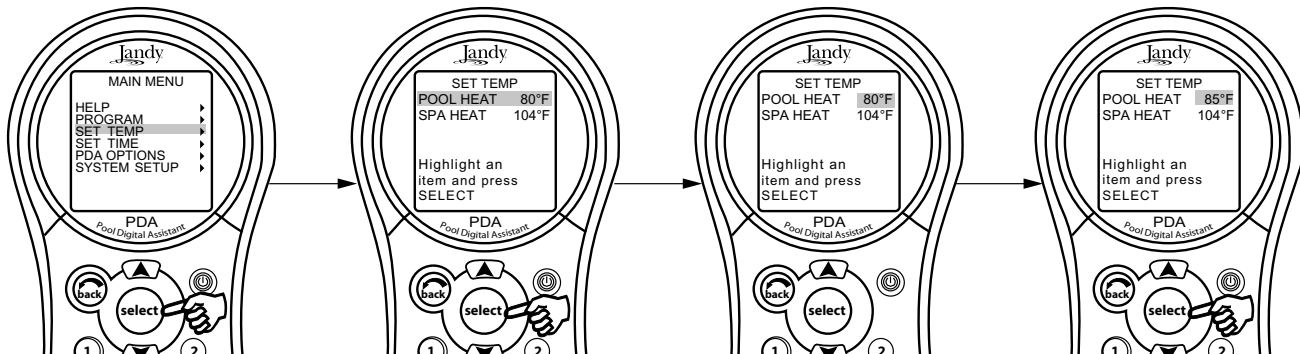

Set Time Menu

The SET TIME menu allows the correct time and date to be entered. The correct time and date ensures that programming will work properly.

NOTE A nine volt (9 V) battery is located at the Power Center that allows the system clock to continue to run during power outages. Ensure that the battery is checked or replaced annually.

To set the Time

Highlight MENU and press SELECT, highlight SET TIME and press SELECT. Use the UP/DOWN arrow keys to set values. Press the SELECT button to continue.

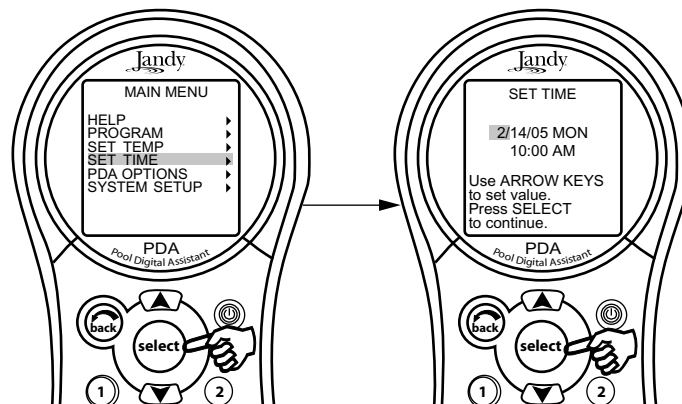

AquaPure Menu

NOTE This equipment may not be part of your system. Please check with your installer.

AquaPure Chlorine Generator systems exclusively communicate with the AquaLink RS. The AquaLink RS PDA Handheld Remote will display % of chlorine output.

This menu item will only appear when an AquaPure chlorine generator is connected to the AquaLink RS system.

To set the AquaPure Output Percentage (%)

Highlight MENU and press SELECT, highlight SET AQUAPURE and press SELECT. Use the UP/DOWN arrow keys to change the percentage.

See page 21 for BOOST options.

NOTE When the Chlorine Generator output percentage is set to a value greater than 0 and the filter pump is on, the system salinity level and output percentage appears on the equipment status screen.

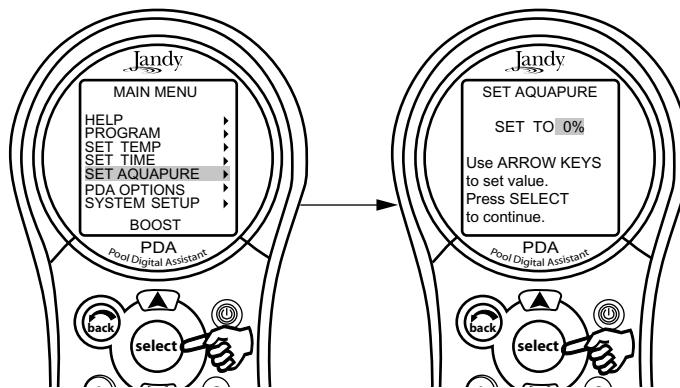

Auto Shut-off Menu

The AUTO SHUT-OFF feature of the handheld remote can be set to a two (2) minute, five (5) minute, or ten (10) minute shut off. The display can be re-enabled by pressing the Power ON/OFF button.

NOTE PDA default is set to two (2) minutes.

To change the Auto Shut-off Time

Highlight MENU and press SELECT. Highlight PDA OPTIONS and press SELECT. Highlight SET AUTO-OFF and press SELECT. Use the UP/DOWN arrow keys to set the time out value. Then press the SELECT button to continue.

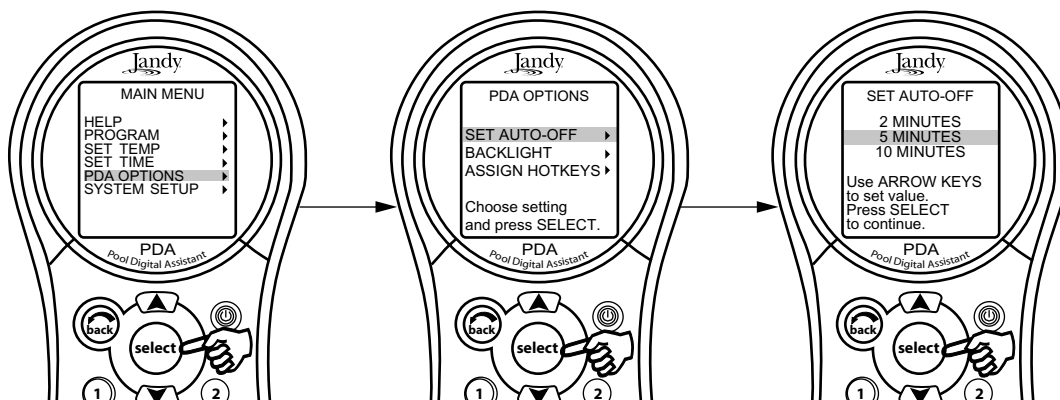

Backlight Menu

The backlight can be turned on and off. Leaving the backlight turned off will extend the battery life.

NOTE Backlight default setting is set to OFF.

To change the Backlight setting

Highlight MENU and press SELECT. Highlight PDA OPTIONS and press SELECT. Highlight BACKLIGHT and press SELECT. Use the UP/DOWN arrow keys to change the setting. Then press the SELECT button to continue.

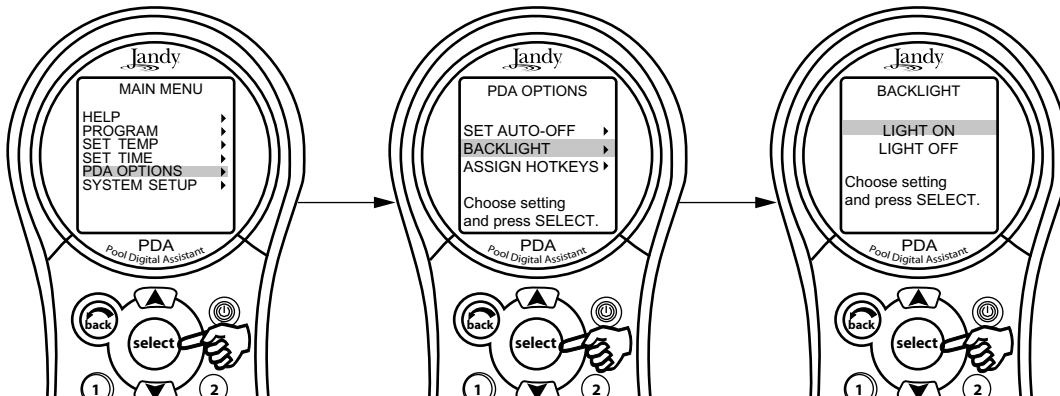

Assign Hotkeys Menu

The 1 and 2 buttons on the AquaLink RS PDA Handheld Remote can be assigned to any piece of equipment connected to a circuit or relay. This provides immediate and dedicated control of the assigned equipment.

NOTE The default setting is AUX1 for button 1 and AUX2 for button 2.

To change the Hotkeys setting

Highlight MENU and press SELECT. Highlight PDA OPTIONS and press SELECT. Highlight ASSIGN HOTKEYS and press SELECT. Highlight 1 or 2 and press SELECT. Use the UP/DOWN arrow keys to change the setting. Then press the SELECT button to continue.

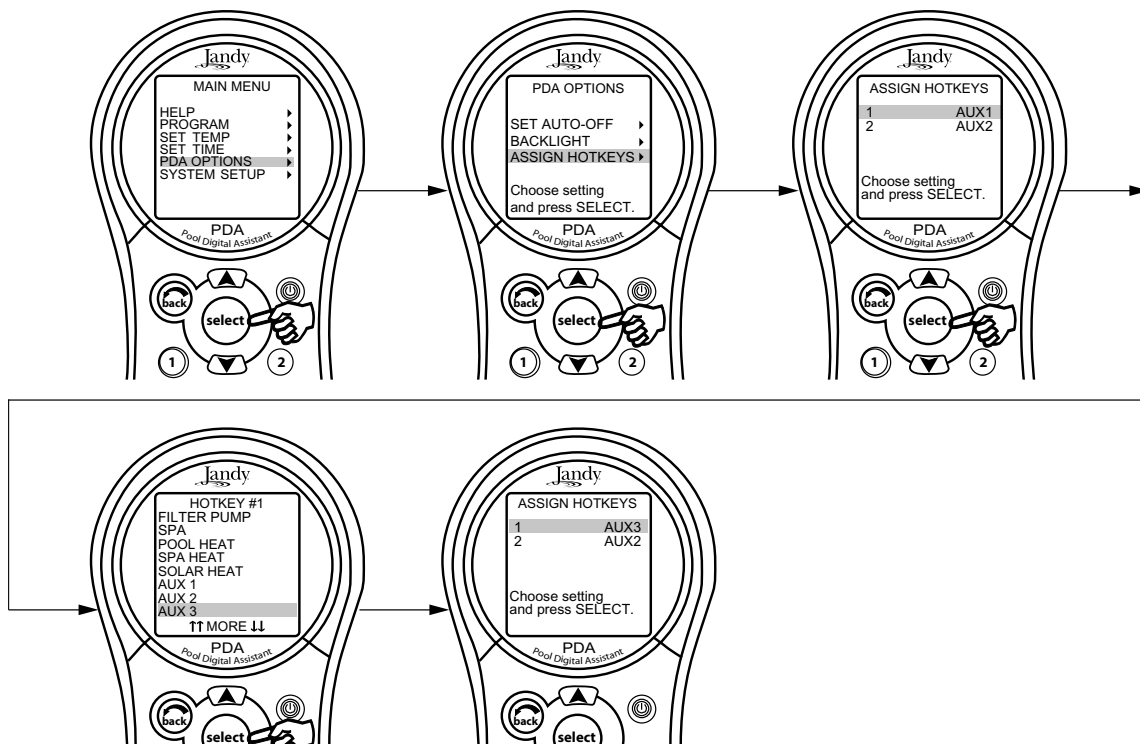

System Setup Menu

Check with installer before making changes to the SYSTEM SETUP.

To use the System Setup menu

Highlight MENU and press SELECT, highlight SYSTEM SETUP and press SELECT. Use the UP/DOWN arrow keys to move the highlight bar up or down to move through the menus. Press SELECT on the highlighted item to move to the next screen.

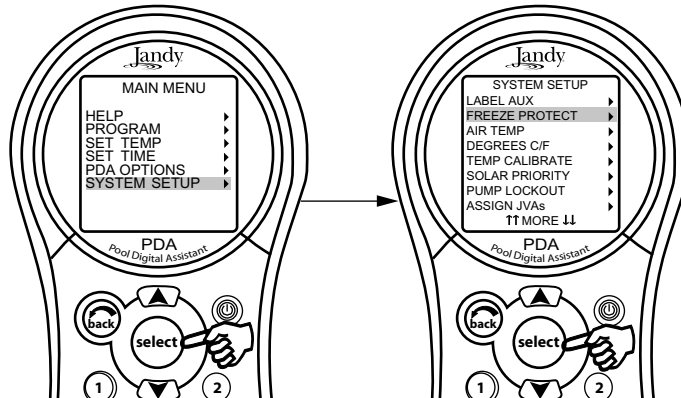

Boost Menu

Activates the BOOST feature that will operate the AquaPure Chlorine Generator at 100% output for 24 hours.

To use the Boost menu

Highlight MENU and press SELECT, highlight BOOST and press SELECT. Highlight START and press SELECT to begin the chlorination cycle.

Use SET AQUAPURE in MENU to set the percentage and the AQUAPURE HOURS in SYSTEM SETUP to set the hours of operation.

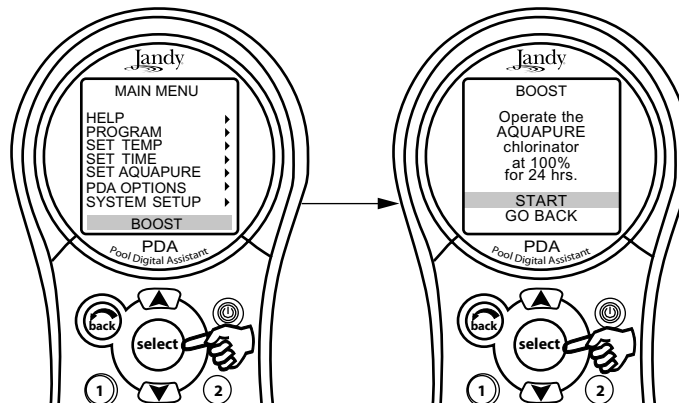

Section 6. Using the System Setup Menu

Label Auxiliary Menu

The LABEL AUX menu allows custom naming of auxiliary equipment. For example, you can set the display to read YARD LIGHT instead of AUX 4.

To use the Label Auxiliary menu

Highlight MENU and press SELECT. Highlight SYSTEM SETUP and press SELECT. Highlight LABEL AUX and press SELECT. Highlight auxiliary to be labeled and press SELECT. Highlight either GENERAL LABELS, LIGHT LABELS, WTRFALL LABELS, or CUSTOM LABEL and press SELECT. Use the UP/DOWN arrow keys to highlight a name and press SELECT.

Under CUSTOM LABEL you may type in any name. Use the UP/DOWN arrow keys to change letters and use SELECT to move to the next letter.

NOTE See Section 9, General, Water Feature, and Light Labels to view the list of available labels.

NOTE Please be aware that if the label NOT USED from the GENERAL LABEL menu is used on an AUX relay, the relay will not engage.

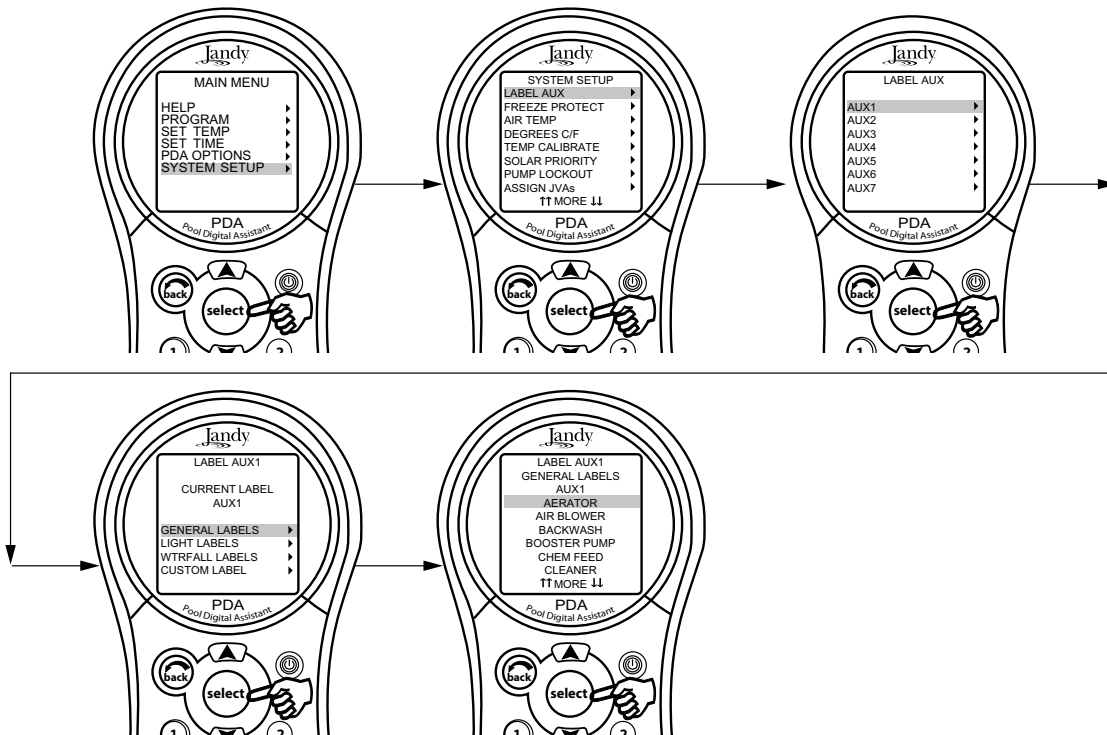

Boost Setup Menu

Use this menu to adjust the number of hours or mode of Boost.

NOTE The MODE selection is only available if the Power Center Bezel dip switch 3 is turned on (Spillover mode). If it is off, then only TIME is displayed.

The system will auto-detect the AquaPure chlorine generator.

To set Boost

Highlight MENU and press SELECT, highlight SYSTEM SETUP and press SELECT, highlight AQUAPURE HRS and press SELECT. Use the UP/DOWN arrow keys to select TIME.

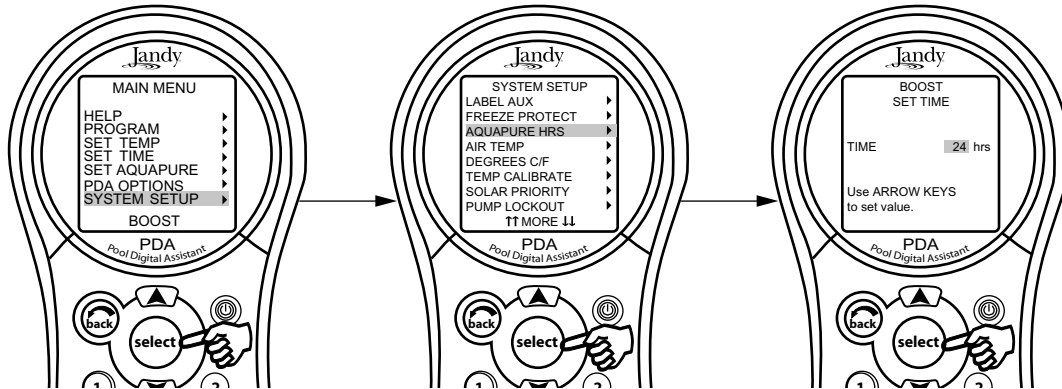

Freeze Protection Menu

Use Freeze Protection menu to assign freeze protection to your pool and spa equipment. When a piece of equipment is assigned to freeze protection, it will turn on when the AquaLink RS detects freezing conditions. The main filter pump is freeze-protected as a default and cannot be removed from freeze protection.

Activation temperature can be adjusted between 32° and 42° F. Once activated, freeze protection will turn off when the air temperature is 2 degrees higher than the activation point.

Important Information on Freeze Protection

Freeze protection is intended to protect equipment and plumbing for short periods of freezing only. It does this by activating the filtration pump and circulating the water to prevent freeze inside equipment or plumbing. Freeze protection does **not** guarantee that equipment will not be damaged by extended periods of freezing temperatures or power outages. In these conditions, the pool and spa should be shut down completely (for example, drained of water and closed for the winter) until warmer weather exists.

⚠ CAUTION

Activating the spa during freezing conditions will override freeze protection. This means that if you are using your spa when freezing conditions exist, freeze protection will **not** circulate water to non-spa related equipment that you may have freeze protected (for example, the pool cleaner or booster pump) and thereby increasing the potential for damage to the equipment.

To use the Freeze Protection menu

Highlight MENU and press SELECT, highlight SYSTEM SETUP and press SELECT, highlight FREEZE PROTECT and press SELECT. Use the UP/DOWN arrows keys to change the activation temperature. Once the temperature is set, use the SELECT button to move to the next screen to assign freeze protection to a selected piece of equipment.

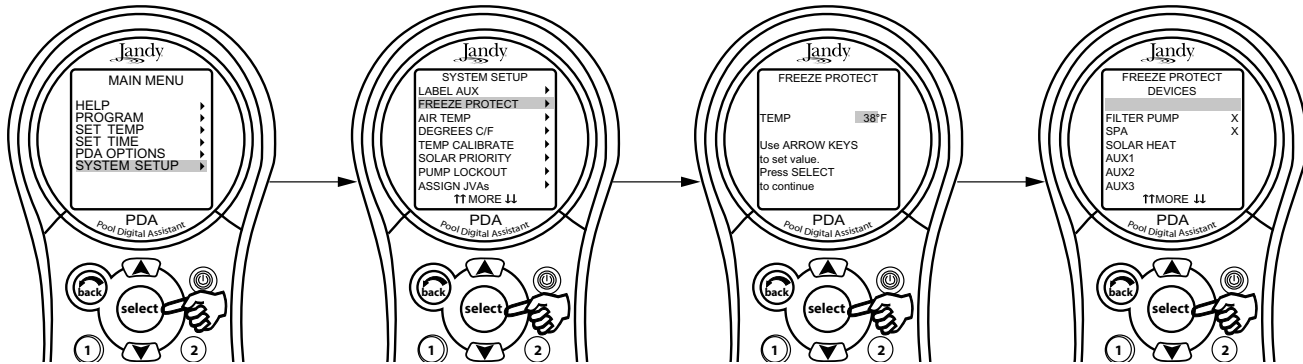

Air Temperature Menu

Use the Air Temperature menu to turn the air temperature display on or off.

To disable Air Temperature display

Highlight MENU and press SELECT, highlight SYSTEM SETUP and press SELECT, highlight AIR TEMP and press SELECT. Use the UP/DOWN arrow keys to highlight desired setting and press SELECT.

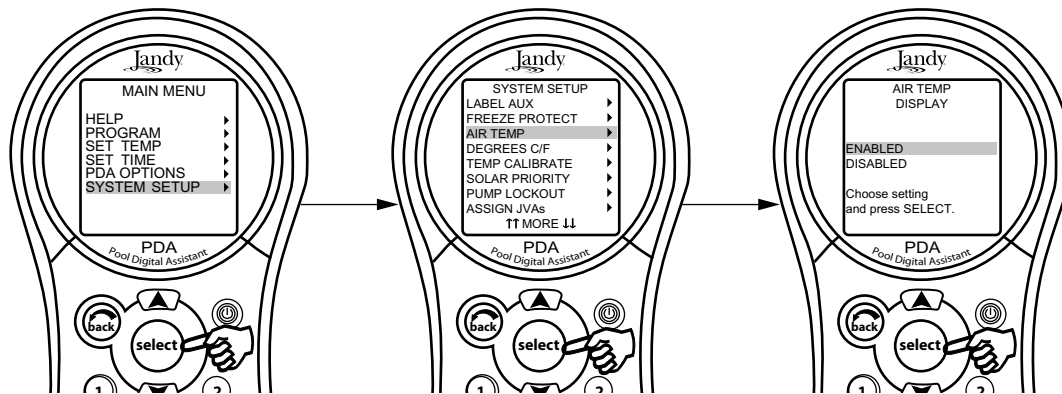

Degrees C/F Menu

The Degrees C/F menu allows you to change the AquaLink RS temperature display from Fahrenheit to Celsius or vice versa. When changing from Fahrenheit to Celsius you will have to re-enter the temperature settings.

To change the Temp readout

Highlight MENU and press SELECT, highlight SYSTEM SETUP and press SELECT, highlight DEGREES C/F and press SELECT. Use the UP/DOWN arrow keys to highlight desired setting and press SELECT.

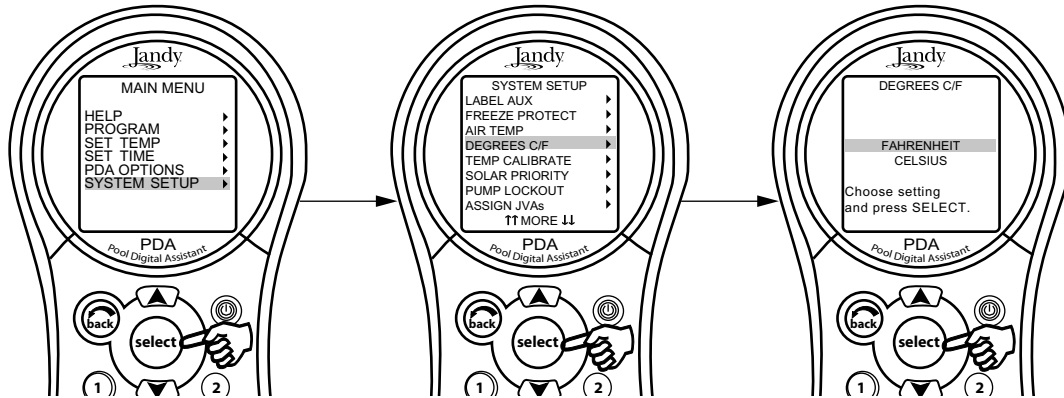

Temp Calibration Menu

This menu allows adjustment of the temperature that is displayed on the AquaLink RS. The temperature can only be adjusted up 4 degrees Fahrenheit or down 4 degrees Fahrenheit, see note below.

To adjust Temperature display

Highlight MENU and press SELECT, highlight SYSTEM SETUP and press SELECT, highlight TEMP CALIBRATE and press SELECT. Use the UP/DOWN arrow keys to set values and press SELECT when finished.

NOTE If the temperature is off by more than four (4) degrees, contact your local service representative.

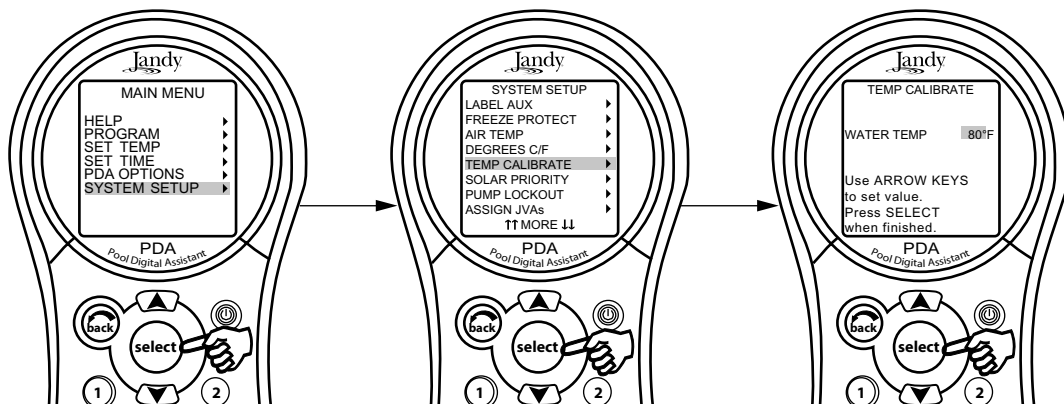

Solar Priority

The Solar Priority menu allows the system to use Solar Heat primarily. If Solar Heat is no longer available, the system will automatically switch to the alternate heat source.

To use the Solar Priority menu

Highlight MENU and press SELECT, highlight SYSTEM SETUP and press SELECT, highlight SOLAR PRIORITY and press SELECT. Use the UP/DOWN arrow keys to highlight desired setting and press SELECT.

When solar and heater are enabled the solar will heat the water until either the thermostat setting has been reached or solar heat is no longer available. If the solar panel is not hot enough, solar heat will shut off and the other heat source (usually gas heater) will take over to bring the water up to the thermostat setting. This menu is used to ENABLE or DISABLE the solar priority.

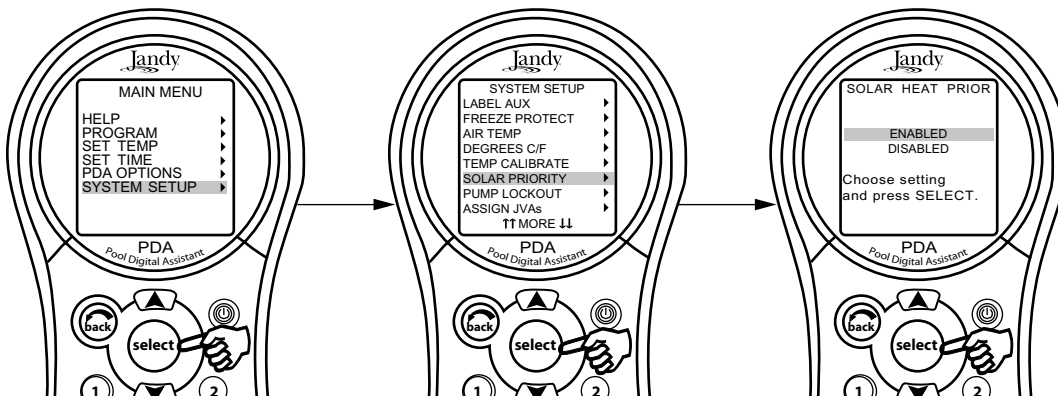

Pump Lockout Menu

The PUMP LOCKOUT menu allows you to enable (pump off) or disable (pump stays on) when valves are rotating from pool to spa.

To set Pump lockout

Highlight MENU and press SELECT, highlight SYSTEM SETUP and press SELECT, highlight PUMP LOCKOUT and press SELECT. Use the UP/DOWN arrow keys to highlight ENABLED or DISABLED and press SELECT.

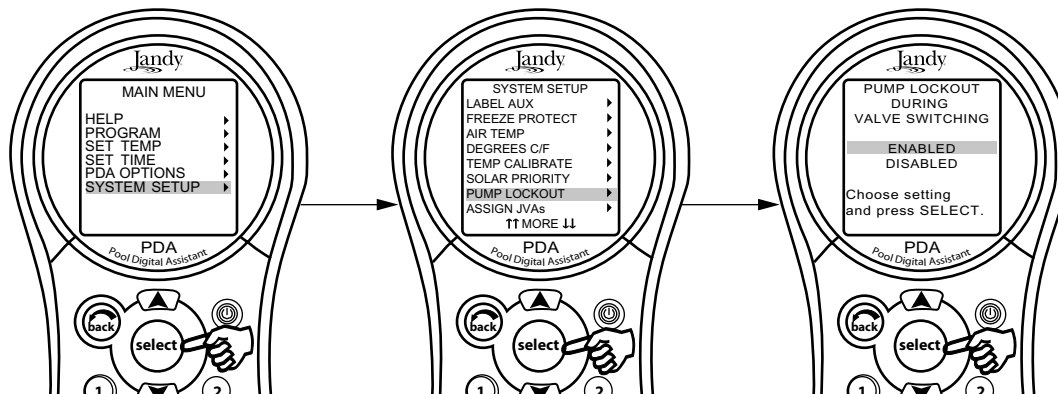

Assign JVA Menu

The ASSIGN JVAs menu allows Jandy Valve Actuators (JVAs) to be assigned to any auxiliary button. This means that whenever you press that auxiliary button, a valve turns. On pool/spa combination models, if neither a non-booster pump pool cleaner or a solar heat system is installed, there are two extra JVAs that can be assigned to auxiliary buttons: the cleaner JVA and the solar JVA. On pool/spa only models, there are four JVAs that can be assigned to auxiliary buttons. The installer must set these JVAs for this feature to operate correctly. Assigning JVAs lets the owner control certain features like diverting water to a waterfall or bank of spa jets. Multiple JVAs can be assigned to one auxiliary button without extra hardware.

To set Assign JVAs

Highlight MENU and press SELECT, highlight SYSTEM SETUP and press SELECT, highlight ASSIGN JVAs and press SELECT. Highlight the JVA you wish to use and press SELECT. Use the UP/DOWN arrow keys to move the highlight bar to the auxiliary button you want to assign, press SELECT to assign the JVA.

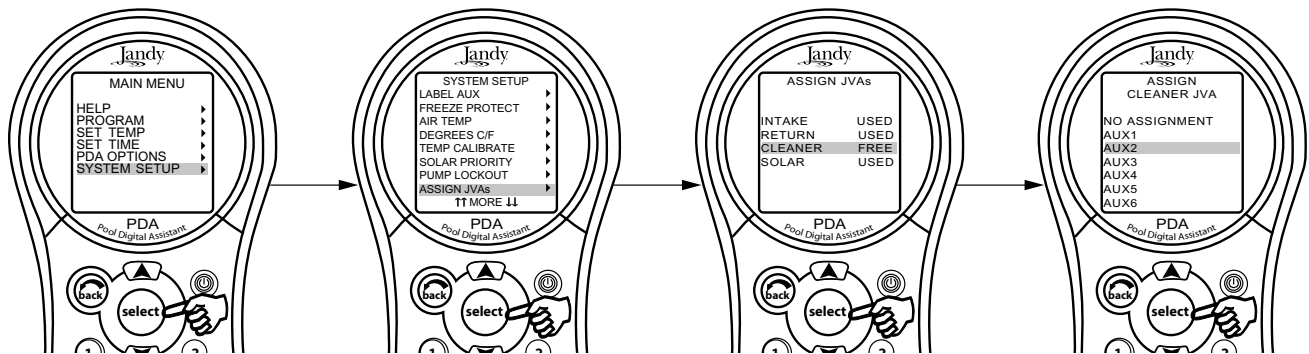

Set Color Lights Menu

NOTE This equipment may not be part of your system. Please check with your installer.

The COLOR LIGHTS menu is used to select the color light type (Jandy or Pentair® SAM™/SAL®), and to assign the color light to an available auxiliary relay.

NOTE You must also label the auxiliary pool or spa light.

To set Color Lights

Highlight MENU and press SELECT, highlight SYSTEM SETUP and press SELECT, highlight COLOR LIGHTS and press SELECT. Use the UP/DOWN arrow keys to highlight the light type to be controlled, then press SELECT. A list of available auxiliaries will be displayed.

Use the UP/DOWN arrow keys to highlight an auxiliary to be assigned to a color light, then press SELECT. An “X” will appear next to the selected item. If the SELECT button is pressed again, while on the same selected item, the “X” will disappear meaning that a color light is no longer being controlled by the auxiliary. Use the BACK button when finished.

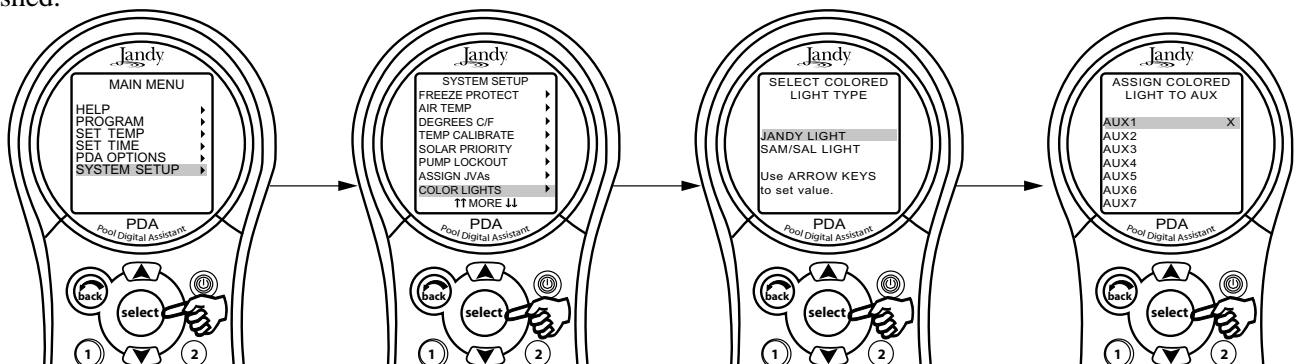

Spa Side Switch Menu

The Spa Side Switch menu allows you to define which equipment is controlled by the buttons on the optional Spa Side Switch(es). Default settings are spa, spa heat, Aux1 and Aux2.

You may want to write down your spa side switch button assignments so that you can label the buttons on the switch with the label pack provided.

To set the Spa Side Switch

Highlight MENU and press SELECT, highlight SYSTEM SETUP and press SELECT, highlight SPA SWITCH and press SELECT. Use the UP/DOWN arrow keys to move the highlight bar to choose which button you are assigning, press SELECT. Use the UP/DOWN arrow keys to move the highlight bar to choose which piece of equipment will be associated with the button, press SELECT. After pressing SELECT on the piece of equipment, you will be returned one screen to continue assigning Spa Side Switch buttons.

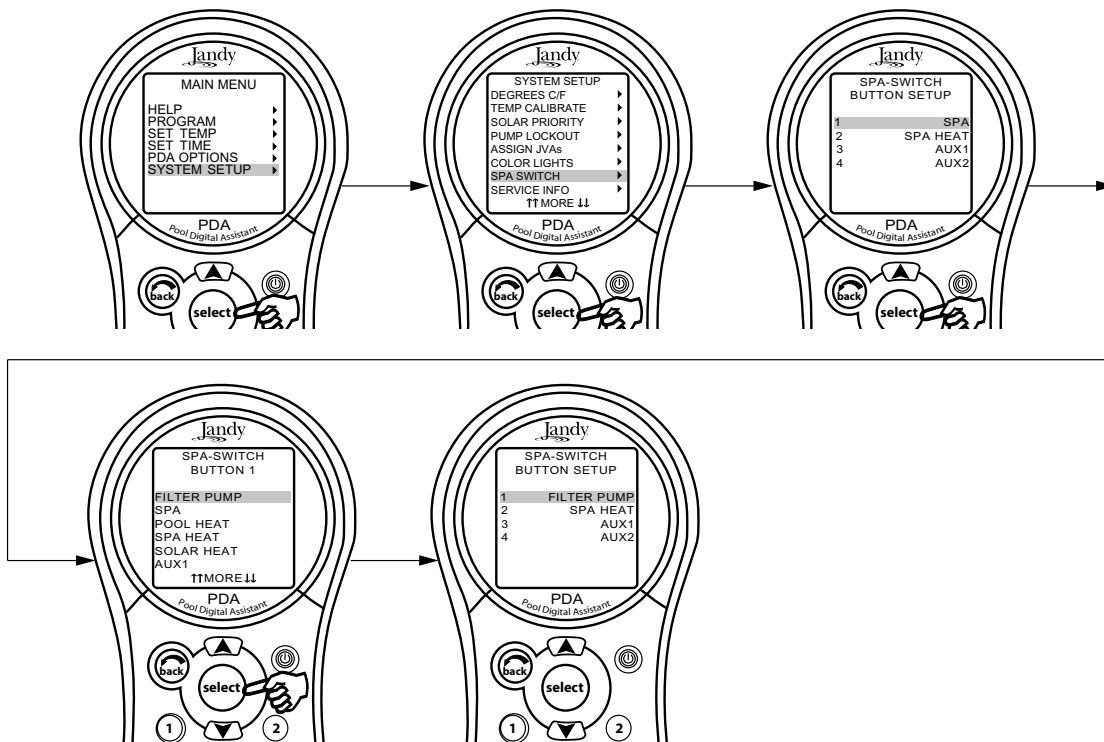

Service Info Menu

The SERVICE INFO menu is used to enter a custom product name, local service company name and telephone number.

To use the Service Info menu

Highlight MENU and press SELECT. Highlight SYSTEM SETUP and press SELECT. Highlight SERVICE INFO and press SELECT. Select either entry to change and press SELECT. You can then change the name of the service company and the phone number.

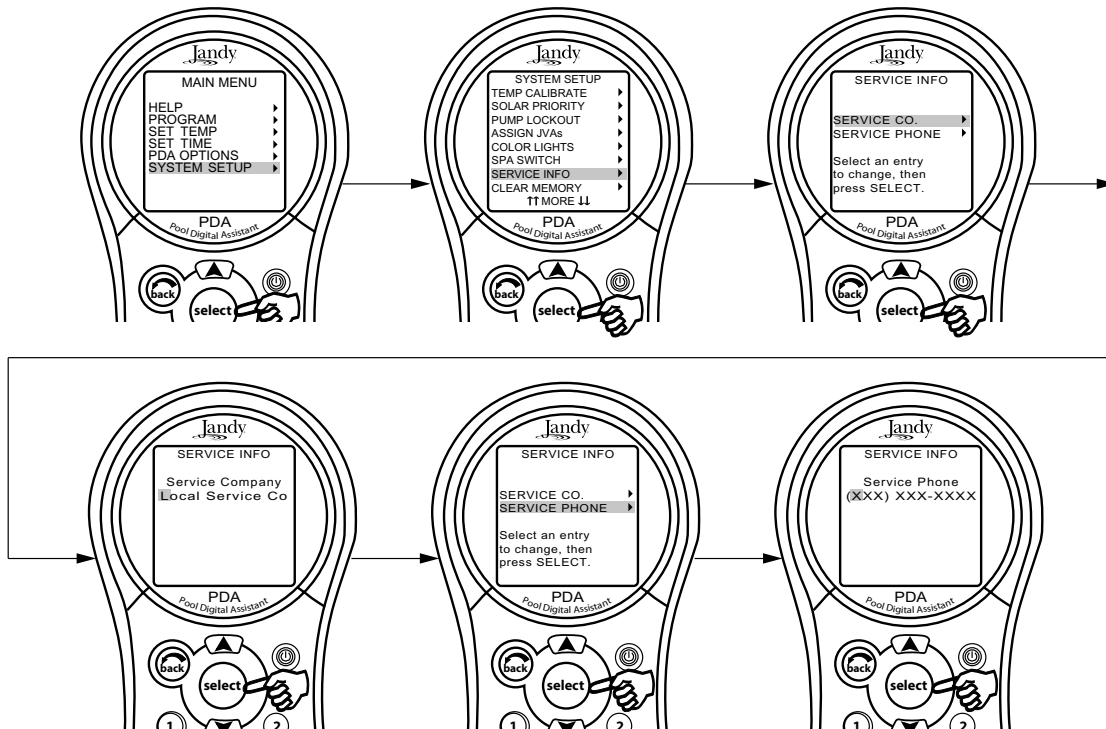

Clear Memory Menu

The CLEAR MEMORY menu will clear all stored values from the AquaLink RS memory. All settings will be reset to their default settings. Stored values include auxiliary labels, all programs, freeze protection settings, remote settings, and thermostat settings. The time and date will not be cleared.

To use the Clear Memory menu

Highlight MENU and press SELECT, highlight SYSTEM SETUP and press SELECT, highlight CLEAR MEMORY and press SELECT. Press SELECT. Use the UP/DOWN arrow keys to select either YES or NO. There will be a delay of 15 seconds before you see the FINISHED screen, select CONTINUE to return to SYSTEM SETUP.

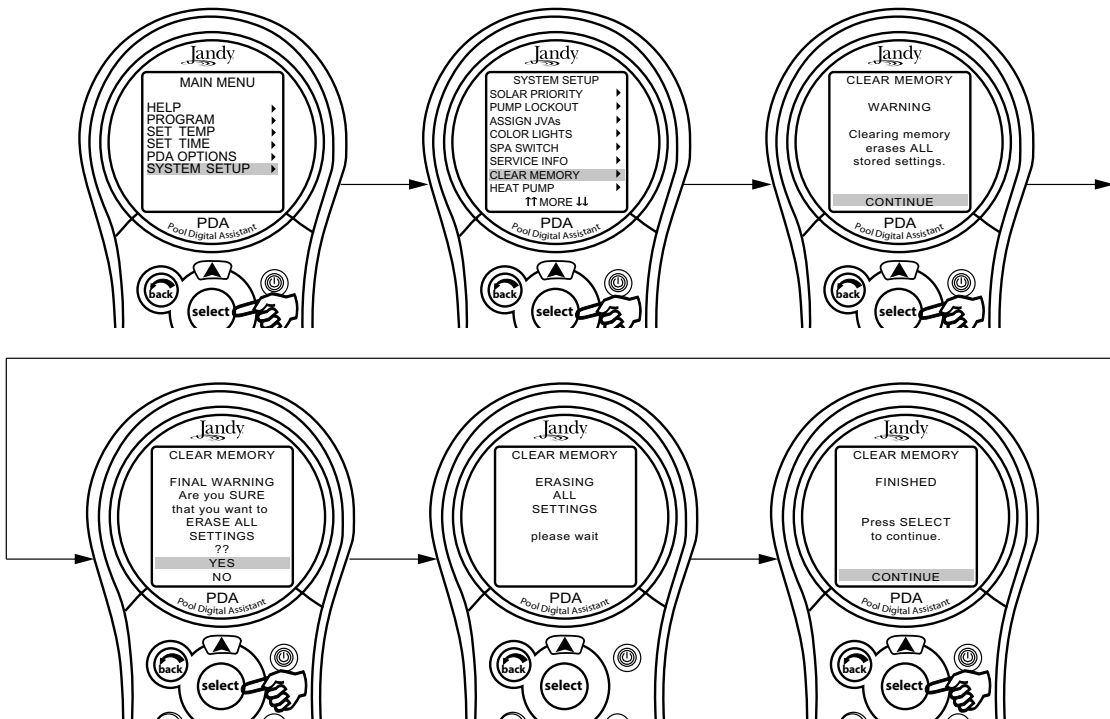

Heat Pump Menu

NOTE This equipment may not be part of your system. Please check with your installer.

The HEAT PUMP SETUP menu is used to put the heat pump into the heat or chill mode. If the heat mode is selected, then HEAT PUMP will be displayed on the EQUIPMENT ON/OFF menu. If chill mode is selected then CHILLER will be displayed on the EQUIPMENT ON/OFF menu.

NOTE In addition to setting heat or chill mode from the Heat Pump Setup menu, the switch on the heat pump must be manually set to heat or chill.

To set the Heat Pump

Highlight MENU and press SELECT, highlight SYSTEM SETUP and press SELECT, highlight HEAT PUMP and press SELECT. Use the UP/DOWN arrow keys to highlight either HEAT or CHILL, then press SELECT. A message will be displayed informing the user that they must walk out to the heat pump and set it to heat or chill mode as well.

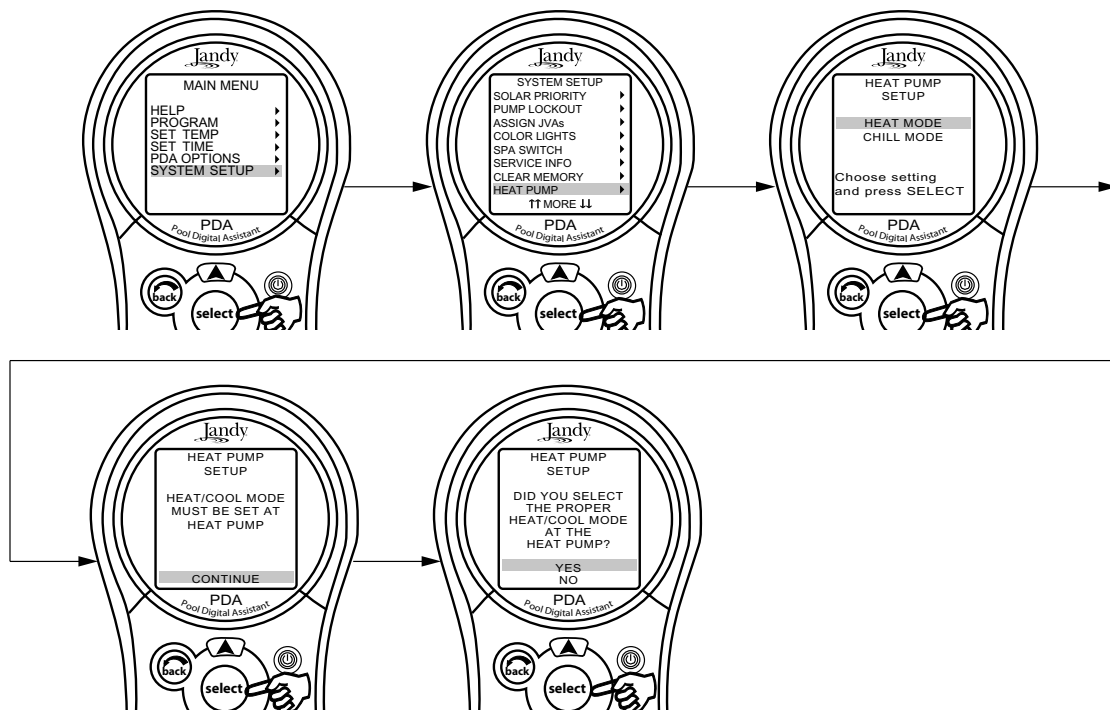

Section 7. Glossaries

7.1 Glossary of Safety Delays

Pool/Spa Switching Filter Pump Delay - The filter pump turns off while valves rotate between pool and spa to prevent damage to the pool equipment. The valves take 35 seconds to rotate between pool and spa; the filter pump will activate as soon as the valves have finished turning.

Heater Cool Down Delay - When the system is heating (water is circulating to the spa) and the Spa button is pressed, the system will remain in Spa Mode for five minutes, and will continue to circulate the water. This delay allows water to cool the heater down by circulating water through it, preventing equipment damage. The five minute delay starts counting down when the heater goes off. If the heater has been off for five minutes or more, prior to turning off the Spa, there will not be a delay.

Heater Start-up - The heater will only come on if the water is circulating (for example, the filter pump is on and has been circulating for 15 seconds) to the corresponding body of water (for example, spa for spa heater) and the actual water temperature is below the temperature you set with TEMP SET in the Menu. If these conditions are not met, the heater will be enabled (ready to go), but will not fire.

Heater "Short Cycling" Prevention - When the heater is activated and the desired temperature is reached, heater will turn off and remain off for 3 minutes, even if the temperature falls below the desired temperature. This feature prevents heater short cycling (in other words, the heater turning off and on in rapid succession).

Cleaner Lockout - The pool cleaner will only activate if the system is in pool mode and water is circulating. The pool cleaner requires that water is circulating to the pool in order for it to operate. Return to pool mode to activate the cleaner.

Spillover Lockout - The spillover will only activate if the system is in pool mode and water is circulating. The spillover requires that water is circulating to the pool in order for it to operate. Return to pool mode to activate the waterfall. Also, if the pool cleaner is on, it will turn off during spillover operation.

Spillover - When Dip Switch 3 is in the ON position, the Aux. 3 relay socket is activated and the return valve actuator turns. The spillover is disabled while the spa is on. A message is displayed when spillover is turned on while in spa mode (water is circulating to spa). The spillover requires that water circulation is to pool in order to operate. The spillover will activate when the system switches back to pool mode.

Enabled - When activated allows the function to work.

Disabled - When activated does not allow the function to work.

7.2 Glossary of Special Auxiliary Labels

Spare AUX- Operates only with Pool/Spa combination units.

Extra AUX- System features (for example, software labeling and timed aux) can be assigned to the EXTRA AUX button. Only freeze protection cannot be assigned to the extra auxiliary.

Air Blower - When an AUX button labeled "Air Blower" is pressed, it will turn on the air blower for 30 minutes, then automatically turn it off. An air blower may be programmed like any other auxiliary, except that you can program only the ON time. The air blower will turn on at the programmed ON time, and turn off 30 minutes later. This is to protect the blower motor from overheating during extended operation.

Fill Line - When an AUX button labeled "Fill Line" is pressed, it will turn on the fill line for 30 minutes, and then automatically turn it off. A fill line may be programmed like any other auxiliary, except that you can program only the ON time. The fill line will turn on at the programmed ON time, and turn off 30 minutes later. This is to avoid overfilling the pool. Choose the appropriate number of "fill" programs during the week to keep your pool at the appropriate level.

7.3 Glossary of PDA Handheld Remote Messages

BATTERY is LOW - This message (located in DIAGNOSTICS under the MENU) indicates that the battery supplying power to the Power Center clock (in case of power outage) is low, and should be replaced. The battery is a standard 9V, and may be replaced by removing the battery door (marked on the Power Center - Power Center is located by the pool equipment).

CLEANER CANNOT BE TURNED ON WHILE SPA IS ON - This message is displayed if the pool cleaner is activated when in spa mode and water is circulating to the spa. The pool cleaner requires that water be circulating to the pool in order for it to operate. Return to pool mode to activate the cleaner.

CLEANER CANNOT BE TURNED ON WHILE SPILLOVER IS ON - The return valve has been rotated to the spa position to give the spa spillover effect.

FREEZE PROTECT - This message indicates that freezing conditions have been detected by the freeze protection sensor, and that equipment assigned to freeze protection are active (for example, the filter pump). See *Section 6, Freeze Protection Menu* on page 23 of this manual for more information.

NOTE The filter pump is always protected; spa and auxiliary circuits can be assigned to freeze protection. If a freeze protected Auxiliary is turned off during freeze protection, a message will be displayed indicating that item is off but will turn on in X amount of minutes. The minutes will vary depending on how long freeze mode has been active from 1 to 15 minutes.

SENSOR OPEN - This error message indicates that the sensor is not installed properly or is malfunctioning. Call your pool service person to resolve this problem.

NOTE If the message reads WATER TEMP OPEN, the heater will not fire. If message AIR TEMP OPEN is displayed, freeze protection will not operate correctly.

POOL HEATER ENABLED - This message indicates that the pool heater is ready to use but is not actually firing. The filter pump must be on, and the water temperature must be below the setting for the heater to fire.

PUMP WILL REMAIN ON WHILE SPILLOVER IS ON - This message is displayed when you attempt to turn off the filter pump while a spa spillover is on. Since the filter pump is necessary for spillover operation, the pump will remain on until the spillover is turned off.

PUMP WILL TURN OFF AFTER COOL DOWN CYCLE - This message indicates that the filter pump is circulating water to cool down the heater. The filter pump will continue to run for five minutes to protect the heater from damage, whenever the heater has fired and has been off for less than 5 minutes.

PUMP WILL TURN ON AFTER DELAY - This message is displayed during pool/spa switching. The AquaLink RS waits 35 seconds while the valves turn from pool position to spa position (or vice-versa) before activating the filter pump.

SERVICE MODE - This message indicates that the PDA Handheld Remote has been locked out from the Power Center and is not operational. Service mode is used by the pool service person to aid them in servicing the pool. The PDA Handheld Remote will not be functional until the switch at the Power Center is moved back to AUTO mode.

SENSOR SHORT - This error message indicates that the sensor is not installed properly or is malfunctioning. Call your pool service person to resolve this problem.

NOTE If the message reads WATER TEMP SHORT, the heater will not fire. If the message AIR TEMP SHORT is displayed, freeze protection will not operate correctly.

SPA WILL TURN OFF AFTER COOL DOWN CYCLE - When the system is in Spa Mode (water is circulating to the spa) and the Spa button is pressed to switch water circulation to the pool, the system will not switch to Pool Mode for five minutes, and will continue to circulate the water (if the heater has fired and has been off for less than five minutes). This delay allows water to cool the heater down by circulating water through it, preventing equipment damage.

TIMEOUT MODE - This message indicates that the PDA Handheld Remote has been locked out from the Power Center and is not operational. TIME OUT mode is used by the pool service person to aid them in servicing the pool. The PDA Handheld Remote will not be functional for three hours, or until the switch at the Power Center is turned back to AUTO mode. The time remaining of TIME OUT mode will appear at the bottom of the PDA screen.

SPILLOVER DISABLED WHILE SPA IS ON - This message is displayed when the spa spillover is pressed while in spa mode (water circulation is to spa). The spillover requires that water circulation is to pool in order to operate. The spillover will activate when the system switches back to pool mode.

Section 8. PDA Handheld Remote Menu Flow Chart

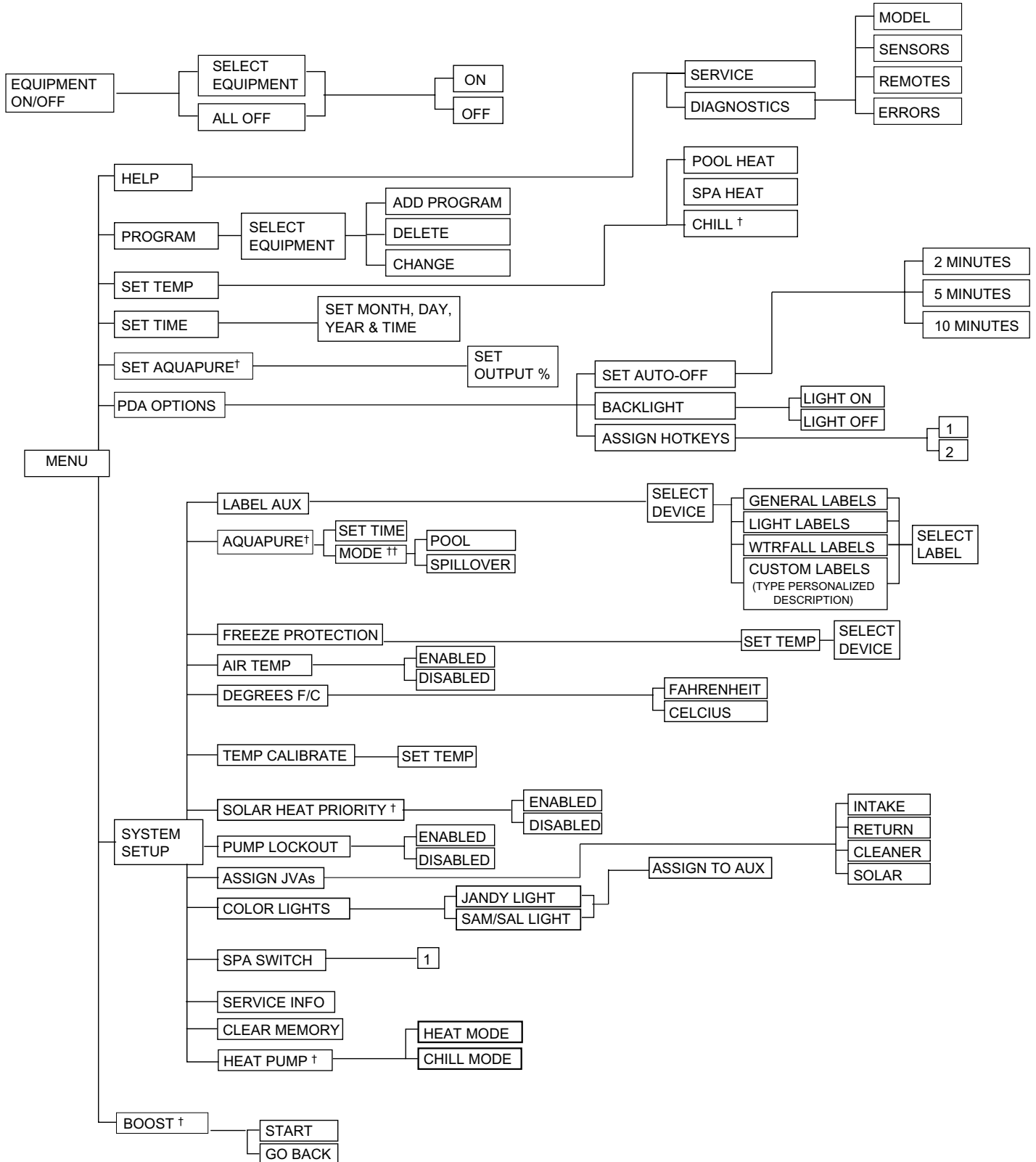

† Items Seen Only With Optional Equipment
 †† Mode Only Displayed When DIP Switch #3 is Set to ON

Section 9. General, Water Feature, and Light Aux Labels

General Labels	Light Labels	Waterfall Labels
Aerator	#1	Waterfall
Air Blower	#2	Waterfall 1
Backwash	#3	Waterfall 2
Booster Pump	Back	Waterfall 3
Chem Feed	Basement	Sheer Dscnt
Cleaner	Beach	Rockfall
Color Wheel	Bedroom	Laminar Jet
Drain Line	Bug	
Fan	Cabana	
Fiber Optic	Color Wheel	
Fill Line	Deck	
Filter Pump	Dock	
Floor System	Drive	
Fogger	East	
Fountain	Entry	
Heat Pump	Equipment	
Heater	Fan	
Hi-E2	Fence	
High Speed	Flood	
Home A/C	Founth	
Home Heat	Front	
Jet Pump	Garage	
Jandy Lite	Garden	
Lamp	Gazebo	
Low Speed	Hall	
Mist	House	
Music	Kitchen	
Not Used (see note)	Laminar Plsr	
Ozonator	Left	
Pond	North	
Ray-Vac	Path	
Slide	Patio	
Solar Pump	Perimeter	
Spa	Pond	
Spillway	Pool	
Sprinkler 1	Porch	
Sprinkler 2	Right	
Sprinkler 3	Room	
Stereo	Sauna	
Stream	Security	
Swim Jet	Shower	
Timed Aux	Shrub	
Valve(s)	South	
Wtr Feature	Spa	
Whirlpool	Statue	
	Steps	
	Table	
	Tier	
	Tree	
	Walk	
	Water Ftr	
	Wtrfill	
	West	
	Yard	

NOTE Please be aware that if the label NOT USED from the GENERAL LABEL menu is used on an AUX relay, the relay will not engage.

NOTES

LIMITED WARRANTY

Thank you for purchasing Jandy® pool and spa products. Jandy Pool Products, Inc. warrants all parts to be free from manufacturing defects in materials and workmanship for a period of one year from the date of retail purchase, with the following exceptions:

- AquaLink® RS units installed with Jandy Surge Protection Kits will be covered for two years.
- NeverLube® valves are warranted for the life of pool and/or spa on which they were originally installed.
- AquaPure™ Electronic Chlorine Generator Electrolytic Cells carry a 5 year limited warranty on a prorated basis.

This warranty is limited to the first retail purchaser, is not transferable, and does not apply to products that have been moved from their original installation sites. The liability of Jandy Pool Products, Inc. shall not exceed the repair or replacement of defective parts and does not include any costs for labor to remove and reinstall the defective part, transportation to or from the factory, and any other materials required to make the repair. This warranty does not cover failures or malfunctions resulting from the following:

1. Failure to properly install, operate or maintain the product(s) in accordance with our published Installation, Operation and Maintenance Manuals provided with the product(s).
2. The workmanship of any installer of the product(s).
3. Not maintaining a proper chemical balance in your pool and/or spa [pH level between 7.2 and 7.8, Total Alkalinity (TA) between 80 to 120 ppm, Total Dissolved Solids (TDS) less than 2000 not including salt ppm].
4. Abuse, alteration, accident, fire, flood, lightning, rodents, insects, negligence or acts of God.
5. Scaling, freezing, or other conditions causing inadequate water circulation.
6. Operating the product(s) at water flow rates outside the published minimum and maximum specifications.
7. Use of non-factory authorized parts or accessories in conjunction with the product(s).
8. Chemical contamination of combustion air or improper use of sanitizing chemicals, such as introducing sanitizing chemicals upstream of the heater and cleaner hose or through the skimmer.
9. Overheating; incorrect wire runs; improper electrical supply; collateral damage caused by failure of O-Rings, DE grids, or cartridge elements; or damage caused by running the pump with insufficient quantities of water.

LIMITATION OF LIABILITY:

This is the only warranty given by Jandy Pool Products, Inc. No one is authorized to make any other warranties on behalf of Jandy Pool Products, Inc. **THIS WARRANTY IS IN LIEU OF ALL OTHER WARRANTIES, EXPRESSED OR IMPLIED, INCLUDING BUT NOT LIMITED TO ANY IMPLIED WARRANTIES OF FITNESS FOR A PARTICULAR PURPOSE AND MERCHANTABILITY. JANDY POOL PRODUCTS, INC. EXPRESSLY DISCLAIMS AND EXCLUDES ANY LIABILITY FOR CONSEQUENTIAL, INCIDENTAL, INDIRECT OR PUNITIVE DAMAGES FOR BREACH OF ANY EXPRESSED OR IMPLIED WARRANTY.** This warranty gives you specific legal rights. You may also have other rights which vary by state or province.

WARRANTY CLAIMS:

For prompt warranty consideration, contact your dealer and provide the following information: proof of purchase, model number, serial number and date of installation. The installer will contact the factory for instructions regarding the claim and to determine the location of the nearest designated service center. If the dealer is not available, you can locate a service center in your area by visiting www.jandy.com or by calling our technical support department at (707) 776-8200 extension 260. All returned parts must have a Returned Material Authorization number to be evaluated under the terms of this warranty.

H0572300A

Jandy®



ETL LISTED
CONFORMS TO
UL STD 1563

CERTIFIED TO
CAN/CSA C22.2 NO. 218.1

PDA HANDHELD REMOTE
FCC ID: S8F826X

PDA TRANSCIVER
FCC ID: S8F8252